



PENN ENERGY RENEWABLES, LTD.
a Penn Real Estate Group, LTD company

Design and Operations Report

In support of an application for a
Renewable Energy Approval (REA)
Pursuant to Ontario Regulation 359/09

For the

Penn Energy – Edwardsburgh_Morrisburg-1

SOLAR ENERGY FACILITY

FIT Contract No. F-000628-SPV-130-505
FIT Application No. FIT-F46NQGB



In the

Township of Edwardsburgh/Cardinal
County of Leeds and Grenville
ONTARIO, CANADA

April 20, 2011

(Revised July 5, 2011)



Printed on 100% recycled paper

A note regarding REA application requirements and additional Project Information:

This document is one component of a series of reports and other related documents that, collectively, constitute a complete Renewable Energy Approval (REA) application package which will be submitted to the Ministry of the Environment (MOE) for review and approval. As such, this report is intended to compliment the other documents and may reference and/or rely upon information contained in them; therefore, the contents herein should not be considered independently.

Table of Contents

1.0 INTRODUCTION 4

2.0 SITE PLANS (refer to Appendix ‘A’ for drawings)..... 5

3.0 FACILITY DESIGN 6

3.1 General Description of REGF’s Design 8

3.2 Potential Negative Environmental Effects attributable to Facility Design 8

4.0 FACILITY OPERATION 9

4.1 Daily Function 9

4.2 Planned Maintenance 10

4.3 Ancillary Activities 10

4.4 Potential Negative Environmental Effects 10

4.4.1 Significant Natural Heritage Features (according to the NHA/EIS) 11

4.4.2 Water Bodies (according to the WA)..... 11

4.4.3 Archeological and Cultural Heritage Features (according to the AA and CHS)..... 11

4.4.4 Acoustic Receptors (according to the AAR) 11

5.0 ENVIRONMENTAL EFFECTS MONITORING PLAN (EEMP) 13

5.1 An Excerpt from the Project Description Report (PDR) 13

5.2 EEMP for Facility Design..... 15

5.3 EEMP for Facility Operation phase 15

6.0 RESPONSE AND COMMUNICATIONS PLAN..... 17

6.1 Communication Methods 18

6.2 Contact Details..... 18

6.3 Response Procedures..... 18

7.0 CONSIDERATION OF OTHER LAND USE PLANNING LAWS 18

 7.1 Niagara Escarpment **(not applicable)** 19

 7.2 Lake Simcoe Watershed **(not applicable)**..... 19

 7.3 Oak Ridges Moraine **(not applicable)**..... 19

 7.4 Greenbelt **(not applicable)**..... 19

8.0 ADDITIONAL REPORTS..... 20



8.1	Effluent Management Plan Report (not applicable)	20
8.2	Emission Summary & Dispersion Monitoring Report (not applicable)	20
8.3	Environmental Impact Study Reports	20
8.4	Hydro-geological Assessment Report (not applicable)	20
8.5	Odour Study Report (not applicable)	20
8.6	Noise Study Report	20
8.7	Property Line Setback Assessment Report (not applicable)	20
8.8	Surface Water Assessment Report (not applicable)	20
8.9	Water Bodies Assessment Report	20
APPENDICES		21
A.	Site Plans	
B.	Solar Photovoltaic (PV) Modules	
C.	Array Racking	
D.	Array Foundations	
E.	Collection Houses and Low-Voltage (DC) Accessories	
F.	Inverters	
G.	Secondary Transformers (at collection houses)	
H.	Primary Transformer (at project substation)	

List of Tables

Table 1.	Description of the Major Equipment and Components of the REGF	7
Table 2.	An Excerpt from the Project Description Report (PDR): Section 4 – Potential (Negative) Environmental Effects (issued April 21, 2010; revised July 5, 2011)	13
Table 3.	EEMP for all identified Potential Negative Environmental Effects	15

Notice:

This document has been prepared solely for the use of Penn Energy Renewables, Ltd. (Penn) as part of the Renewable Energy Approval (REA) process in accordance with Ontario Regulation 359/09. It is in DRAFT form and subject to further revision. The content of this document is not intended for the use of – nor is it intended to be relied upon by – any other person, firm or corporation. Penn denies any liability whatsoever to other parties for damages or injury suffered by such third party arising from use of this document by them. Neither Penn nor any of its directors, officers or employees, shall have any liability (for negligence or otherwise) to any third party for any use of this document for any reason whatsoever.



1.0 INTRODUCTION

Penn Energy Renewables, Ltd. (Penn) has executed a FIT contract with the Ontario Power Authority (OPA) for the construction of a 10 MW, ground-mounted, Class 3 solar energy facility near the Town of Prescott, in the County of Leeds and Grenville, Ontario. The subject lands are located in part of Lot 34 Concession 1 of the Township of Edwardsburgh/Cardinal (former Township of Edwardsburgh). The proposed Renewable Energy Generation Facility (REGF) would consist of a collection of solar photovoltaic (PV) modules (each approximately 1.00 m x 1.67 m or 1.00 m x 2.00 m in dimension) that are grouped into arrays tilted and facing south. These stationary arrays are strung together forming a series of rows oriented east to west. The Environmental Protection Act (EPA) administered by the Ministry of the Environment (MOE) regulates Renewable Energy Approvals (REAs) under Part V.0.1 of the act, pursuant to Ontario Regulation 359/09. A proponent of a renewable energy project is required to submit numerous reports as part of an REA application; one of which is a Design and Operations Report (DOR).

According to the MOE's publication "Technical Bulletin #2: Guidance for preparing the Design and Operations Report as part of an application under O.Reg.359/09 (Draft document posted for public comment on the Environmental Registry March 1, 2010)" ...^a

The Design and Operations Report is the principal document where the details of a renewable energy project are presented. It builds on the Project Description Report by defining:

- *the exact site plan;*
- *the design of the facility and the equipment to be used;*
- *how the project will be operated;*
- *how environmental effects will be monitored and mitigated; and*
- *how emergencies and communications will be managed.*

This report begins with a description of the various items illustrated in the Site Plan drawings (see Appendix 'A') and then discusses Design of the proposed REGF, including specifications of its primary components (see Appendices). It continues by outlining the scope of work and detailing specific tasks for the Operations phase of this project. The potential for any negative environmental effects due to the REGF design or operational activities are examined and any mitigation or monitoring is proposed in the Environmental Effects Monitoring Plan (EEMP). Next is a description of the Response plan which lists contact information and procedures for both emergency and non-emergency communications. Finally are references to any other land use planning laws or additional reports that may apply.

^a *This Technical Bulletin (PIBS 7437e) is one in a series that was proposed and posted on the Government of Ontario, Canada's Environmental Registry website www.ebr.gov.on.ca in Draft form in March 2010 for a 90-day public review and comment period which ended May 30, 2010. As of the date of publication of this DOR, the Technical Bulletins have not yet been finalized nor formally adopted as Policy by the Ministry of the Environment. Nevertheless, Penn has referenced this series of Draft Bulletins and sought to address the applicable suggestions included therein.*



Because of its low-impact nature in comparison to other forms of power generation, many DOR items listed in O.Reg. 359/09 (Table 1, Item 4) are not applicable to solar PV facilities; accordingly, these items are not included in this report (e.g. sewage, air contaminants, organic and other waste). It should also be noted that this project is not located within the Oak Ridges Moraine Conservation Plan Area, the Niagara Escarpment Plan Area, the Greenbelt's Protected Countryside or the Lake Simcoe Watershed.

2.0 SITE PLANS (refer to Appendix 'A' for drawings)



3.0 FACILITY DESIGN

Pursuant to Item 2 for DOR in Table 1 of O.Reg. 359/09, proponents shall set out conceptual plans, specifications and descriptions related to the **Design** of the REGF, including descriptions of:

- i. **Sewage (n/a)** There will be no works for the collection, transmission, treatment and disposal of sewage (including sediment control features and storm water management facilities).
- ii. **Air contaminants (n/a)** There will be no things that discharge contaminants into the air.
- iii. **Other Waste (n/a)** There will be no systems, facilities and equipment for receiving, handling, storing and processing any waste, biomass, source separated organics, farm material and biogas.

The MOE's publication "Technical Bulletin #2 (Draft)" suggests that the Design Plan should:

"Describe the types, sizes, and design of proposed facility components. The focus...should be to detail attributes of the project that have the potential to cause negative environmental effects...For environmental effects that have been addressed by adhering to setback distances (for instance, avoiding development within 120 metres of a significant natural feature), this mitigation approach should be noted.

It also advises that applicants should include the following technology-specific items to describe the Design of solar projects:

- **Make and Model of Solar Module (see Table 1, below, and Appendices)**
- **Diagram of the dimensions of each solar module (see Table 1 and Appendices)**
- **Diagram and specifications of how the solar modules are mounted (see Table 1 and Appendices)**
- **Description of the mechanism and range of motion if solar modules track the sun (n/a: fixed racking)**
- **Description of how power is inverted, transformed and transmitted, including specifications of all power conversion equipment (see Table 1 and Appendices)**
- **Description of any treatments to land on which the solar modules are proposed, particularly with regard to soil permeability and the potential for negative environmental effects related to stormwater runoff from the facility**
 - **The PV modules are mounted above grade – allowing for grass to be propagated below and between the array tables.**
 - **The foundation system is relatively minimal and consists of generously spaced posts or piers (only one per every 6-15 modules, depending on final engineering) which amounts to a very small footprint on the soil itself. These posts are the only point of contact between the arrays and the ground. The posts occupy substantially less than one percent (1%) of the site area (approximately 0.0015). Accordingly, any change to stormwater runoff will be diminimus.**
 - **There will be no paving. The access lanes are farm lanes; if required, they will be stabilized with gravel, which is typically considered a pervious surface.**
 - **The collection houses and transformer stations will also occupy substantially less than one percent (1%) of the site area (approx. 0.00075).**



- **Together these factors will avoid concentration of runoff and significantly decrease (if not eliminate altogether) the amount of precipitation that will not be absorbed by the soils in the immediate vicinity. It is anticipated that there will be little, if any, change to the quantities or rates of stormwater runoff. Compared to the pre-development condition, any impact is too negligible to warrant stormwater management controls.**

Table 1. Description of the Major Equipment and Components of the REGF:

Major Equipment and Components	Description* (per subparagraph ii)	Notes*
Solar Photovoltaic (PV) Modules	MaxPower CS6X by Canadian Solar, or similar: 265-295 watts each (+5w tolerance); nominal dimensions: 1.0 m x 2.0 m; Poly- crystalline or Mono-crystalline silicon; aluminum frame; tempered glass cover	<i>See Appendix 'B'</i>
Array Racking	ISYS Ground-Mount by UniRac; Solar Flexrack™ by NSM; or similar Aluminum or galvanized steel members	<i>See Appendix 'C'</i>
Array Foundations	Driven piers or ground screws by TerraFix, Krinner or similar (galvanized steel) **	<i>See Appendix 'D'</i>
Collection Houses (see Inverters and Secondary Transformers, below)	PV Box by Schneider Electric, or similar	<i>See Appendix 'E'</i>
Low-Voltage (DC) Accessories into and within collection houses	Low-Voltage wiring strings, combiners, junction boxes, collection cabling, surge arrestors & related protection equipment, security & communications accessories, etc. by Schneider Electric or similar	<i>See Appendix 'E'</i>
Inverters (DC to AC)	Xantrex GT-500 (500 kW each) by Schneider Electric, or similar	2 per collection house <i>See Appendix 'F'</i>
Secondary Transformers (1 mVA)	Class 7230 Pad-Mounted Small Power transformer (208 V to 27.6 kV) by Schneider Electric, or similar	1 per collection house <i>See Appendix 'G'</i>
Primary Transformer (10 mVA)	Class 7240 Substation Small Power transformer (27.6 kV to 44 kV) by Schneider Electric, or similar utilizing biodegradable transformer oil.	Only 1 (at the project substation) <i>See Appendix 'H'</i>
Medium-Voltage (AC) electrical equipment from collection houses to project substation and interconnection point	Medium-Voltage conductors, switchgear, disconnects, SCADA, meter, etc. <i>Currently being determined through ongoing coordination and negotiations with Hydro One Networks (HONI).</i>	to be determined

* Specifications for major equipment and components are subject to change.

** Prior to the construction of the foundations for the solar arrays, Penn will request permission from the owners of properties within 120 meters of the Project Location to conduct testing of the existing water wells located within 120 meters of the Project Location (the “Well Testing Zone”). Provided that the owners grant this permission prior to foundation installation, Penn will conduct testing of the water quality of the existing wells in the Well Testing Zone. Penn will maintain the testing results as a baseline for use in evaluating any future claims of impacts to the wells caused by the project (including particularly the installation of the foundations).



3.1 General Description of REGF's Design

The proposed REGF consists of a collection of solar photovoltaic (PV) modules (each approximately 1.0 m x 2.0 m in dimension) that are grouped into arrays, tilted and facing south. These stationary arrays are strung together forming a series of rows oriented east to west. Electricity collection and distribution lines link the PV modules to a collection house with inverter and transformer equipment. Penn anticipates selecting a primary transformer for the grid-tie substation that utilizes biodegradable transformer oil(s), such as, by way of example, vegetable-based FR-3. Such transformer oils are non-toxic and readily biodegradable. They are less volatile than petroleum-based oils and have higher flash points for improved safety. They are known to quickly and thoroughly degrade in both soil and aquatic environments. For this size of operation 10-15 collection houses are anticipated. Laneways provide access to each collection house. The entire operation (solar modules, collection houses and access lanes) will be fenced in order to provide for safety and security, in accordance with applicable requirements. The fence is designed according to applicable legislations (such as Ontario Electric Safety Board). A perimeter lane would be constructed immediately inside of the fence. The access lanes (perimeter lane and laneways to collection houses) would be typical farm lanes. If necessary, they will be stabilized with gravel. The solar modules are placed above the ground and as such allow for grass to be established underneath. The foundation system for the arrays would be completed by pile driving or core drilling pipes into the ground. The exact methods will be decided during final project engineering.

3.2 Potential Negative Environmental Effects attributable to Facility Design (according to the NHA/EIS, AA and WA)^b

As the project's design has evolved the REGF layout has been modified substantially. Each time significant environmental features were identified, setbacks/buffers were established and the project footprint was pulled-back from those features in an effort to avoid any negative effects on significant woodlands, and wildlife movement corridors. For example, as stated in the NHA...

"... the initial concept plan included the removal of woodland on the north end of the study area which would have resulted in the loss of 4.6 ha of interior habitat from the eastern patch. By leaving the northern section of the woodland untouched, impacts to the eastern patch of the interior habitat will now be avoided. Furthermore, based on comments received from OMNR, the wayside pit is now being avoided which eliminated indirect impacts to the woodlands..")

It should be noted that both the Ministry of Natural Resources and the Ministry of Tourism and Culture have reviewed the applicable reports by our professionals and have confirmed and/or concurred with the findings.

Conclusion: No negative environmental effects attributable to the Design of the REGF are anticipated; therefore, neither mitigation measures nor monitoring are necessary.

^b Much of the information in Subsections 3.2, 4.4 and Section 5 is taken from other reports prepared for this REA application, for example, the Natural Heritage Assessment and Environmental Impact Study Report by Bowfin Environmental Consulting (NHA/EIS), the Cultural Heritage Screening Results by Unterman McPhail Associates (CHS), the Archaeological Assessment (Stages 1 and 2) Report by Northeastern Archaeological Associates (AA), the Water Assessment Report by Bowfin Environmental Consulting (WA) and the Acoustic Assessment Report by HGC Engineering (AAR). Please refer to these companion reports for more detailed information.



4.0 FACILITY OPERATION

Pursuant to Item 3 for DOR in Table 1 of O.Reg. 359/09, proponents shall set out conceptual plans, specifications and descriptions related to the **Operation** of the REGF, including descriptions of:

- i. Water Taking (n/a) No water takings associated with the operation of the facility are planned. During the operations phase of the project, Penn anticipates that it will clean the modules twice per year. The duration of the module cleaning scope of work is approximately one week. It is anticipated that the module cleaning process will use not more than 30,240 liters of water per day on any day.
- ii. Sewage (n/a) No sewage will be produced.
- iii. Air contaminants (n/a) No air contaminants are expected to be discharged from the REGF.
- iv. Bio/Organic Waste (n/a) No biomass, source separated organics or farm material will be accepted or used at the facility.
- v. Other Waste (n/a) No waste will be generated as a result of the solar power generation process.

The MOE's publication "Technical Bulletin #2 (Draft)" states that the Operational Plan should...

"Describe the daily function of the project in generating electricity and any planned maintenance or ancillary activities that will occur continuously or intermittently over the course of the project life. The plan should emphasize how operations may contribute to or mitigate negative environmental effects. It should also include a discussion of site supervision and staff training.

It also suggests that...

"Solar energy projects may have unique considerations that should be discussed in the Operational Plan. Some examples include (amongst others determined by the applicant):

- *How the land upon which the solar modules are mounted will be managed to maintain specified land use conditions. This could include procedures to limit the growth of vegetation. This should be described if such activities have the potential to cause negative environmental effects; and*
- *How solar modules will be maintained including a description of all maintenance activities, their frequency, and any operational details that contribute to the evaluation of negative environmental effects.*

4.1 Daily Function

One of the attributes of solar PV generation that sets it apart from other power sources is the passive nature of the system components. Coupled with monitoring and communications technology/SCADA, this passive nature allows for remote operations support. With that said, a caretaker (possibly living onsite) will regularly attend to the facility, albeit primarily for non-operations related purposes (see Ancillary Activities, below). No negative



environmental effects attributable to the Daily Function of the REGF are anticipated; therefore, neither mitigation measures nor monitoring are necessary.

4.2 Planned Maintenance

Regularly scheduled service activities will be conducted at the proposed REGF throughout the operational phase, the majority of which will occur once or twice per year. Due to the scarcity of moving parts in solar PV generation components – in comparison to other forms of power generation – maintenance work will consist primarily of visual inspection of equipment & accessories to verify they are functioning properly and to ensure all connections (structural and electrical) are secure. It also entails cleaning or replacing filters and managing spare parts and consumables. On a related note, the need for un-planned maintenance may arise (e.g. due to failure of equipment/accessories or a weather-related issues). Once a problem is identified – most likely via the remote monitoring and support system – a properly trained individual or team will be dispatched to diagnose and address the issue.

4.3 Ancillary Activities

Activities that are supplementary to the operational portions of the facility include: grass maintenance; removal of invasive vegetation, debris and combustible materials; snow removal; monitoring for animal activity and related damage. During the operations phase of the REGF, grass maintenance will include regular mowing, within the facility and the landscaped areas outside the perimeter fence along the southern boundary. An area that is a maximum of 5 m wide on the outside of the perimeter fence on the western, northern and eastern boundaries will also be mowed regularly to ensure that no woody vegetation would become established where it could cause damage to the fence or shade the solar modules. Additionally, there is a possibility that fencing, security & communications systems, internal lane-ways, site entrance drive, collection houses, HVAC equipment, etc. may occasionally need repairs. This work will be implemented as necessary by an individual or team properly trained to address the issue.

4.4 Potential Negative Environmental Effects^c

As noted earlier, no negative environmental effects are expected from the Daily Function of the REGF. Although the Planned Maintenance and Ancillary Activities are relatively meager, there remains potential for negative impact on significant woodlands and wildlife movement corridors. The following lists the identified features, evaluates potential impacts, and identifies any for which mitigation measures and/or monitoring is warranted.

c Much of the information in Subsections 3.2, 4.4 and Section 5 is taken from other reports prepared for this REA application, for example, the Natural Heritage Assessment and Environmental Impact Study Report by Bowfin Environmental Consulting (NHA/EIS), the Cultural Heritage Screening Results by Unterman McPhail Associates (CHS), the Archaeological Assessment (Stages 1 and 2) Report by Northeastern Archaeological Associates (AA), the Water Assessment Report by Bowfin Environmental Consulting (WA) and the Acoustic Assessment Report by HGC Engineering (AAR). Please refer to these companion reports for more detailed information.



4.4.1 Significant Natural Heritage Features (according to the NHA/EIS)

- A. Significant Woodland: *“Following the removal of this very small portion of the woodland, the forest patch will continue to meet PPS criteria for significant woodland based on both size and ecological functions. Despite the loss of 1.6 ha of the woodland interior habitat from the western interior patch, the interior habitat is anticipated to function as it currently does, prior to the proposed REGF project, since the area is limited in its pre-existing condition by its size, lack of maturity and fragmentation. Provided that the mitigation measures are implemented and that best practices are utilized during construction, the potential impacts to the woodland during all phases are considered to be local, permanent to repetitive, and negligible..”*
- B. Wildlife Movement Corridor: While the REGF is does not contain any known wildlife corridors, there is a possibility, albeit unlikely, that wildlife may find their way inside the perimeter fence and need assistance finding an exit. Noise from machinery and vehicles is another potential impact requiring care to avoid.

4.4.2 Water Bodies

None. The *Water Assessment Report* by Bowfin Environmental Consulting found there are no lakes or lake trout lakes within 300 m of the REGF project location. Even though the results of records review and site investigations identified several areas in or within 120m of REGF project location that required consideration, Bowfin confirmed that no water bodies (as defined by O.Reg. 359/09) are located within the study area. Additionally, a follow-up telephone conversation between MOE and Bowfin held on March 22nd, 2011, determined that no scoping meeting was warranted.

4.4.3 Archeological and Cultural Heritage Features (according to the AA and CHS)

None. The MTC has reviewed the Stage 1 and 2 Archeological Assessment Report prepared by Northeastern Archeological Associates of Port Hope, ON. An Archeology Review Officer has stated that the MTC believes this assessment complies with the Ontario Heritage Act and that the Ministry is satisfied with the recommendations included therein.

The *Cultural Heritage Screening* by Unterman McPhail Associates found that the proposed REGF is neither located on nor abuts any Protected Properties (as listed in the Table for section 19 of O.Reg. 359/09). It also confirmed there are no heritage resources – other than those described in the s. 19 Table – at the project location.

4.4.4 Acoustic Receptors (according to the AAR)

None. The *Acoustic Assessment Report* by HGC Engineering concluded the following...

“The acoustical analysis indicates that the sound emissions of the proposed solar plant will be 5db below the exclusionary minimum criterion, to ensure that the overall sound levels from the Edwardsburgh_Morrisburg Solar Plant will comply with the applicable sound limits set by MOE Guideline NPC-205.”



Conclusion: No negative environmental effects attributable to the Daily Function of the REGF are anticipated. Regarding the Planned Maintenance and Ancillary Activities, however, some potential remains for negative impact on the woodland and wildlife habitat, which can be avoided by following the EEMP below.



5.0 ENVIRONMENTAL EFFECTS MONITORING PLAN (EEMP)

Pursuant to Item 4 for DOR in Table 1 of O.Reg. 359/09, proponents shall include an **Environmental Effects Monitoring Plan (EEMP)** in respect of any negative environmental effects that may result from engaging in the renewable energy project, setting out

- i. Performance objectives in respect of the negative environmental effects,
- ii. Mitigation measures to assist in achieving the performance objectives mentioned in subparagraph i,
- iii. A program for monitoring negative environmental effects for the duration of the time that the project is engaged in, including a contingency plan to be implemented if any mitigation measures fail.

The MOE’s publication “Technical Bulletin #2 (Draft)” suggests that the EEMP should include the following, using summary tables and text descriptions as well as references to other reports as required:

- *A summary of all potential negative environmental effects caused by the project as given in the description of negative environmental effects in the Project Description Report. This summary is included for context.*
- *Performance objectives in respect of each potential negative effect. Performance should be defined such that in achieving the objective the negative effect will be mitigated*
- *A description of all mitigation strategies planned to achieve performance objectives*
- *Where there is an ongoing risk of potential negative environmental effects, description of how the project will be monitored to ensure that mitigation strategies are meeting performance objectives*

5.1 An Excerpt from the Project Description Report (PDR)

Table 2. Section 4 – Potential (Negative) Environmental Effects:

Land Ownership	REGF site is privately owned (no Crown or Federal lands involved)
Legal description	Concession 1, (part) Lot 34
Cultural Heritage & Archeological (MTC)	None. In respect of Protected Properties, Unterman McPhail Associates (UMA) of Toronto, ON has screened the property and verified that the proposed project is not located on nor does it abut any protected properties as described in Column 1 of the Table to section 19 of O.Reg. 359/09. UMA also verified there are no other heritage resources at the project location (in addition to defined protected properties). Additionally, the MTC has reviewed the Stage 1 and 2 Archaeological Assessment Report prepared by Northeastern Archaeological Associates of Port Hope, ON. An Archaeology Review Officer has stated that the MTC believes this assessment complies with the Ontario Heritage Act and that the Ministry is satisfied with the recommendations included therein.
Natural Heritage (MNR) <i>Significant woodlands, valleylands, wildlife habitat, wetlands, provincial parks, conservation areas &</i>	REGF is not located within 120m of a Provincial Park or Conservation Reserve nor within 50m of ANSI-earth science. According to the Natural Heritage Assessment and Environmental Impact Study Report prepared by Bowfin Environmental Consulting of Cornwall, ON (and confirmed by MNR’s Kemptville District Manager): <i>“The proposed project is located within an area that was once used as grazing lands.</i>



<p>reserves, flora/fauna species of concern & habitat, protected natural areas (e.g. ANSI), and locally important or valued ecosystems or vegetation within 120m of the project location</p>	<p>Site investigations found that the habitats consisted of fallow fields, windrows, plantations, deciduous thickets, woodlands and forests and all well as three small (non-significant) wetlands. The only confirmed significant natural features are significant woodlands and wildlife movement corridor. While the significant woodland is located within the project study area, following re-design of the site plan and the use of properly implemented mitigation measures there are no anticipated measurable negative impacts to these features. The wildlife movement corridor is located 110 m from the REGF project location and is not anticipated to be impacted by any of the phases of this project. Since no significant natural feature will be measurably impacted, no monitoring plan is recommended.</p> <p>It also notes: <i>“The initial concept plan included the removal of the woodland on the north end of the study area, which would have resulted in the loss of 4.6 ha of interior habitat from the eastern patch. By leaving the northern section of the woodland untouched, impacts to the eastern patch of the interior habitat will now be avoided. Furthermore, based on comments received from OMNR, the wayside pit is now being avoided which eliminates indirect impacts to the adjacent woodlands.</i>”</p>
<p>Water Bodies (CA, MNR)</p>	<p>Bowfin Environmental Consulting of Cornwall, ON conducted a Water Assessment and has confirmed through records review and site investigations that there are no water bodies in or within 120m of the project location, nor any lake trout lakes within 300m of the project location.</p>
<p>Air, Odour, Dust</p>	<p>No odors or dust emissions are produced by solar power generation equipment.</p>
<p>Noise</p>	<p>Minimal sound is emitted by the solar power generation process. The panels, racking and wiring – which comprise the majority of the REGF components – produce virtually no sound. The inverter and transformer, however, do produce some noise. This equipment was studied in accordance with O.Reg. 359/09 and by HGC Engineering of Mississauga, ON. Their acoustic assessment report was prepared according to Appendix A of the MOE’s “Basic Comprehensive Certificates of Approval (Air) – User Guide”, dated April 2004 and is submitted herewith. As evidenced in the report, the prescribed noise limits will be adhered to via careful siting of the suspect equipment adequately distanced from any receptors.</p>
<p>Land Uses (past & present; onsite & nearby)</p>	<p>No negative effects on the current land use or resource availability are anticipated. The proposed REGF site is undeveloped and currently under-utilized. It has, however, been used for livestock grazing in the past. Almost all adjacent land is also undeveloped, except for parcels along CR-2 (King St.) where there is an ethanol plant, a recycling center, a truck depot, a port, a salt storage facility, and a handful of residences between CR-2 and river. With the exception of the northernmost corner (along the CNR railway), almost the entire site has been cleared in the past, and sparse forest resources (of questionable value) remain. The previous landowner removed some aggregate material from a small portion of site.</p>
<p>Record of Site Condition (any potential for existing contamination?)</p>	<p>There is no expectation that the site is contaminated, and the need to obtain a Record of Site Condition (RSC) is not anticipated. Based upon a comprehensive Title Search and review of a Custom Environmental Risk Information Report by EcoLog ERIS Ltd. of Toronto, ON, no potential for existing contamination has been identified.</p>
<p>Provincial & Local Infrastructure</p>	<p>No negative environmental effect is anticipated on provincial and local services and infrastructure. This site is located within the township’s Economic Enterprise Policy Area (zoned for industrial, intensive commercial, etc. uses), and the REGF requires no sewer or gas services. County Rd. 2, which serves this EE zone, is already well-travelled by large trucks serving the Port of Prescott (grain elevator, salt, and aggregates) as well as a multitude of existing industrial neighbors – including the recycling center, an expanding ethanol plant, and a few manufacturing facilities. While there will be a temporary increase of truck traffic on CR-2 during the few months of construction, it will be relatively minor – compared to existing traffic – and there will be almost no traffic generated by this REGF once construction is complete.</p>



Public Health & Safety	No negative environmental effect on public health and safety is anticipated. In fact, there are numerous <u>benefits</u> provided by generating solar power, which is why the provincial government is encouraging it. The facility will be surrounded by a fence for safety and security.
Provincial Plan Areas	Not Applicable, since the project is not within a PPA.

5.2 EEMP for Facility Design

Subsequent to significant site plan modifications throughout the design phase, no negative environmental effects are attributable to the Design of the REGF. Therefore, neither mitigation measures nor monitoring are necessary.

5.3 EEMP for Facility Operation phase

As noted earlier, no negative environmental effects are expected from the Daily Function of the REGF, but the potential for impact on the woodland and offsite wildlife movement corridor does exist related to Planned Maintenance and Ancillary Activities. The possible negative environmental effects include: harm to trees not intended for removal; wildlife that find their way inside the perimeter fence; and noise from machinery and vehicles. According to the NHA/EIS,

“While the significant woodland is located within the project study area, following re-design of the site plan and the use of properly implemented mitigation measures there are no anticipated measurable negative impacts to these features. The wildlife movement corridor is located 110 m from the REGF project location and is not anticipated to be impacted by any of the phases of this project.”

Table 3. EEMP for all identified Potential Negative Environmental Effects:

Performance Objectives	Mitigation Measures	Monitoring Program
Avoid harm to trees not intended for removal	<ol style="list-style-type: none"> Clearly indicate limits/perimeter of area to be mowed around the perimeter fence to prevent impacts to the woodland feature. Utilize small machinery (such as a lawn tractor) within 25 m of woodlands when repairing any damage to the fence or perimeter lane to minimize potential damage to root systems of trees not intended for removal. 	None.
Avoid holding wildlife inside REGF project area fence	Should wildlife be observed within the fenced in area, the gate will be left open to allow them to leave.	Caretaker and other operations or maintenance staff to be observant while onsite.
Avoid harm to wildlife	<ol style="list-style-type: none"> Initial mowing will commence before April 15th or after July 31st, unless a biologist clears site via Monitoring Program (see Monitor 	<ol style="list-style-type: none"> While mowing, operator will visually scan the area for wildlife to minimize harm thereto. If necessary, biologist to walk the site no



	<p>Program #2).</p> <p>2. Ensure that properly operating mufflers are used on all project machinery and vehicles to minimize noise impacts.</p>	<p>earlier than five days prior to planned clearing and indicate that no nesting activity is occurring within the area to be cleared. (see Mitigation #1)</p>
--	---	---



6.0 RESPONSE AND COMMUNICATIONS PLAN

Pursuant to Item 5 for DOR in Table 1 of O.Reg. 359/09, proponents shall include a **Response Plan** setting out a description of the actions to be taken while engaging in the renewable energy project to inform the public, aboriginal communities and municipalities (Township and County)^d with respect to the project, including

- i. Communication Methods: Measures to provide information regarding the activities occurring at the project location, including emergencies **(see 6.1, below)**
- ii. Contact Details: Means by which persons responsible for engaging in the project may be contacted **(see 6.2), and**
- iii. Response Procedures: Means by which correspondence directed to the persons responsible for engaging in the project will be recorded and addressed. **(see 6.3)**

The MOE's publication "Technical Bulletin #2 (Draft)" suggests that the Response Plan should include the following components:

- Contact Details: A plan for communications in the event of an emergency including key contact information and a description of the chain of communications between the proponent and relevant responders under emergency scenarios applicable to the project. **(see 6.2, below)**
- Communication Methods: Description of how the information will be disseminated to all relevant responders such as the local fire department. **(see 6.1)**
- Non-Emergencies: A plan for non-emergency communications related to the project. This should describe how the public and other organizations will be provided information about the project. This could include notification of any project changes, results of the ongoing project monitoring, or other matters considered relevant by the applicant. **(see 6.1 thru 6.3)**
- Response Procedures: A plan for receiving communications from the public and any stakeholder. This should describe how the public and any stakeholders will be directed to correspond with the proponent, how correspondence will be recorded, how the proponent will address any concerns raised, and the communications plan for the response. This should also describe if/how correspondence will be shared with other stakeholders such as the Ministry of the Environment. The procedure for recording any complaints from the public should include the following: **(see 6.3)**
 - (a) Recording each complaint in a log book or in an electronic file. The information recorded shall include name, address and the telephone number of the complainant; time and date of the complaint, details of the complaint; actions taken to remediate the cause of the complaint; and proposed actions to be taken to prevent reoccurrence in the future.

d The proposed REGF is not located within the jurisdiction of a local roads board or a local services board, but both the upper-tier and lower-tier municipal bodies were consulted throughout the due diligence and design phases of this project. Feedback received from the Township and County representatives is documented in the Draft Consultation Report which is another component of the complete REA application package which will be submitted to the Ministry of the Environment (MOE) for review and approval.



(b) Notifying the Ministry's Spills Action Centre at 1-800-268-6060 of the receipt of the complaint.

6.1 Communication Methods

Throughout all site-related phases (construction, operation and decommissioning) of the REGF, signage with instructions and contact information for emergencies and non-emergencies will be posted for the public and any stakeholder.

6.1.1 Emergencies

1. Immediately dial **911** for all emergencies
2. Then call REGF proponent's representative: **1-610-668-0300**.

6.1.2 Non-Emergencies

1. Contact the REGF proponent's representative via phone, fax or post (see 6.2.2 for details).

6.2 Contact Details

6.2.1 Emergencies

1. Phone: **911**
2. Owner's representative: **1-610-668-0300** (Penn Energy Renewables)

6.2.2 Non-Emergencies

1. Owner's representative: Penn Energy Renewables
 - a. **1-610-668-0300** phone
 - b. **1-610-668-0365** fax
 - c. **620 Righters Ferry Road, Bala Cynwyd, PA 19004 USA**

6.3 Response Procedures

6.3.1 Emergencies

1. Owner's representative will follow-up with local authorities and remain in contact as appropriate until the emergency is resolved.

6.3.2 Non-Emergencies

1. All inquiries from the public or any stakeholder will be directed to an appropriate team member for a verbal or written response.
2. All written correspondence will be saved in digital format and will include:
 - a. name, address and telephone number of inquirer;
 - b. time and date of initial contact; and
 - c. if appropriate, action(s) proposed to resolve any issues and prevent reoccurrence.
3. Proponent may share inquiry and response with appropriate stakeholder (e.g. local jurisdiction, provincial ministry, etc.).
4. In the event of a qualifying spill, proponent will notify the Ministry's Spills Action Centre at 1-800-268-6060 following receipt of the complaint.



7.0 CONSIDERATION OF OTHER LAND USE PLANNING LAWS

7.1 Niagara Escarpment (not applicable)

The proposed REGF is not located within the Niagara Escarpment Plan Area.

7.2 Lake Simcoe Watershed (not applicable)

The proposed REGF is not located within the Lake Simcoe Watershed.

7.3 Oak Ridges Moraine (not applicable)

The proposed REGF is not located on land subject to the Oak Ridges Moraine Conservation Plan.

7.4 Greenbelt (not applicable)

The proposed REGF is not located within the Protected Countryside of the Greenbelt.



8.0 ADDITIONAL REPORTS

8.1 Effluent Management Plan Report (not applicable)

The proposed REGF is not an anaerobic digestion or thermal treatment facility.

8.2 Emission Summary & Dispersion Monitoring Report (not applicable)

The proposed REGF is not an anaerobic digestion, thermal treatment or bio-fuel facility.

8.3 Environmental Impact Study Reports

Please refer to the EIS Report (section 6.0 of the Natural Heritage Assessment, under separate cover) by Bowfin Environmental Consulting.

8.4 Hydro-geological Assessment Report (not applicable)

The proposed REGF is not an anaerobic digestion or thermal treatment facility.

8.5 Odour Study Report (not applicable)

The proposed REGF is not an anaerobic digestion or bio-fuel facility.

8.6 Noise Study Report

Please refer to the Acoustic Assessment Report (under separate cover) by HGC Engineering.

8.7 Property Line Setback Assessment Report (not applicable)

The proposed REGF is not a wind energy project.

8.8 Surface Water Assessment Report (not applicable)

The proposed REGF is not an anaerobic digestion or thermal treatment facility.

8.9 Water Bodies Assessment Report

As documented in the *Water Assessment* by Bowfin Environmental Consulting (under separate cover), the results of the records review and site investigations identified no lake trout lakes in or within 300m of the REGF Project Location, nor any features that meet the O.Reg. 359/09 definition of “water bodies” in or within 120m of the REGF Project Location; therefore, a Water Bodies Report is unnecessary.



APPENDICES

- A. Site Plans
- B. Solar Photovoltaic (PV) Modules
- C. Array Racking
- D. Array Foundations
- E. Collection Houses and Low-Voltage (DC) Accessories
- F. Inverters
- G. Secondary Transformers (at collection houses)
- H. Primary Transformer (at project substation)



APPENDIX 'A'

Site Plans



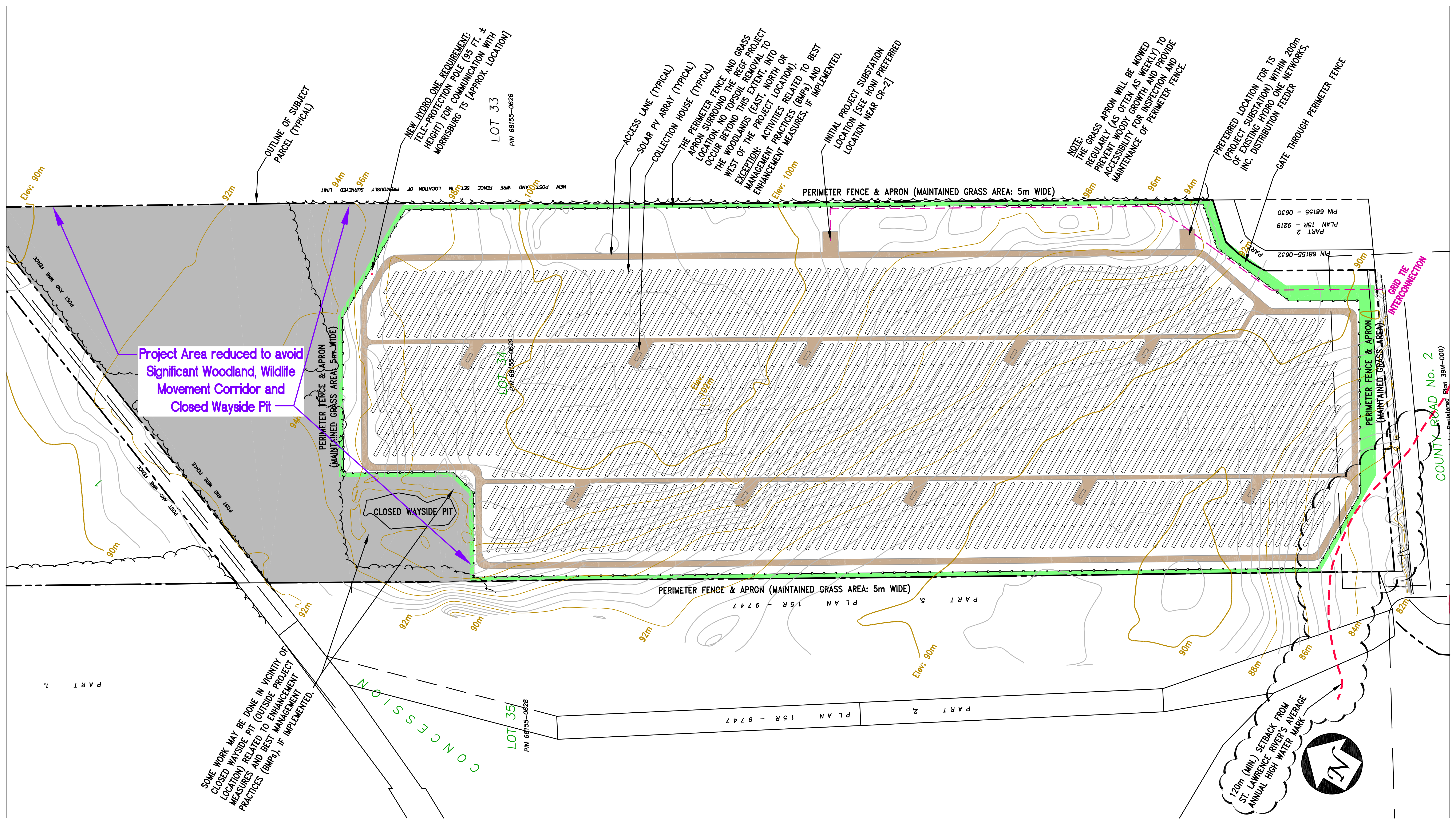

NOTE: The intent of this drawing is to illustrate proposed development limitations and major project components. The facilities within the "Project Location" are conceptual in nature and subject to change as the project design is further refined and engineered.

Revisions:

9/27/11 Setback from St. Lawrence River; Removed Exclusion from Project Location due to clearance from Archaeologist and Ministry of Culture

Site Plan with Existing Topography
 for Proposed Solar Energy Facility: "Edwardsburgh_Morrisburg-1"
 JULY 5, 2011 © Penn Energy Renewables, Ltd.
 REVISED Sept. 27, 2011

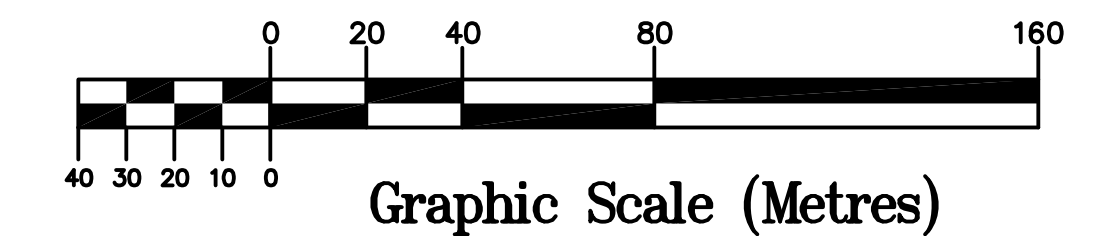

APPENDIX 'B'

Solar Photovoltaic (PV) Modules



MaxPower CS6X

280/285/290/295M



Key Features

- Industry largest silicon solar module, generating more Watt per panel and reducing BOS cost
- 6 years product warranty (materials and workmanship); 25 years module power output warranty
- Industry leading plus only power tolerance: +5W (+1.7%)
- Strong framed module, passing mechanical load test of 5400Pa to withstand heavier snow load
- The 1st manufacturer in the PV industry certified for ISO:TS16949 (The automotive quality management system) in module production since 2003
- ISO17025 qualified manufacturer owned testing lab, fully complying to IEC, TUV, UL testing standards

All-purpose Module

MaxPower CS6X is a robust solar module with 72 solar cells. These modules can be used for on-grid solar applications. Our meticulous design and production techniques ensure a high-yield, long-term performance for every module produced. Our rigorous quality control and in-house testing facilities guarantee Canadian Solar's modules meet the highest quality standards possible.

Applications

- Utility
- Commercial/industrial roof-tops
- Rural area applications
- Other on-grid and off-grid applications

Quality Certificates

- IEC 61215 / IEC 61730, UL 1703, CEC Listed, CE, MCS
- ISO9001: 2008: Standards for quality management systems
- ISO/TS16949:2009: The automotive quality management system

Environment Certificates

- ISO14001:2004: Standards for Environmental management systems
- QC080000 HSPM: The Certification for Hazardous Substances Regulations



CS6X-280/285/290/295M MaxPower

Electrical Data

		CS6X-280M	CS6X-285M	CS6X-290M	CS6X-295M
Nominal Maximum Power at STC (Pmax)		280W	285W	290W	295W
Optimum Operating Voltage (Vmp)		36.0V	36.1V	36.3V	36.4V
Optimum Operating Current (Imp)		7.78A	7.89A	8.00A	8.11A
Open Circuit Voltage (Voc)		44.6V	44.7V	44.7V	44.9V
Short Circuit Current (Isc)		8.30A	8.40A	8.51A	8.63A
Operating Temperature		-40°C~+85°C			
Maximum System Voltage		1000V (IEC) /600V (UL)			
Maximum Series Fuse Rating		15A			
Power Tolerance		+5W			
Temperature Coefficient	Pmax	-0.45%/°C			
	Voc	-0.35 %/°C			
	Isc	0.06 %/°C			
	NOCT	45°C			

Under Standard Test Conditions (STC) of irradiance of 1000W/m², spectrum AM 1.5 and cell temperature of 25°C

Mechanical Data

Cell Type	Mono-crystalline
Cell Arrangement	72 (6 x 12)
Dimensions	1954 x 982 x 40mm (76.93 x 38.7 x 1.57in)
Weight	27kg (59.52 lbs)
Front Cover	Tempered glass
Frame Material	Anodized aluminium alloy
Standard Packaging (Modules per Pallet)	20pcs

Engineering Drawings

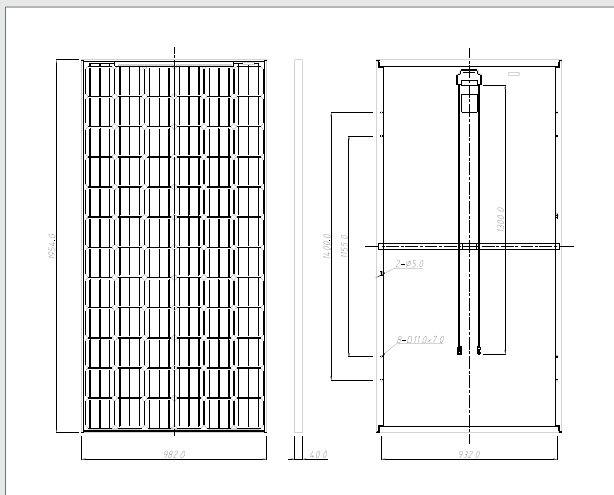

*Specifications included in this datasheet are subject to change without prior notice.

I-V Curves (CS6X-295M)

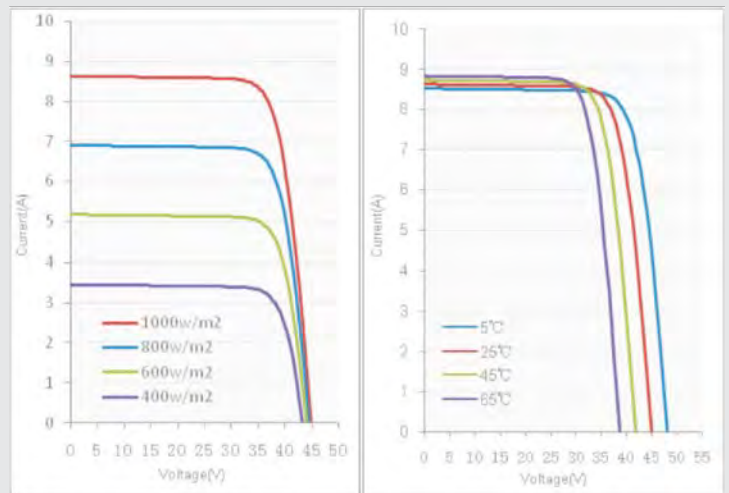

About Canadian Solar

Canadian Solar Inc. is one of the world's largest solar companies. As a leading vertically-integrated manufacturer of ingots, wafers, cells, solar modules and solar systems. Canadian Solar delivers solar power products of uncompromising quality to worldwide customers. Canadian Solar's world class team of professionals works closely with our customers to provide them with solutions for all their solar needs.

Canadian Solar was founded in Canada in 2001 and was successfully listed on NASDAQ Exchange (symbol: CSIQ) in November 2006. Canadian Solar has expanded its cell capacity to 800MW and module capacity to 1.3GW in 2010.

Headquarters | 650 Riverbend Drive, Suite B
Kitchener, Ontario | Canada N2K 3S2
Tel: +1-519-954-2057
Fax: +1-519-578-2097
inquire.ca@canadiansolar.com
www.canadiansolar.com

MaxPower CS6X

265/270/275/280/285P



Key Features

- Industry largest silicon solar module, generating more Watt per panel and reducing BOS cost
- 6 years product warranty (materials and workmanship); 25 years module power output warranty
- Industry leading plus only power tolerance: +5W (+1.8%)
- Strong framed module, passing mechanical load test of 5400Pa to withstand heavier snow load
- The 1st manufacturer in the PV industry certified for ISO:TS16949 (The automotive quality management system) in module production since 2003
- ISO17025 qualified manufacturer owned testing lab, fully complying to IEC, TUV, UL testing standards

All-purpose Module

MaxPower CS6X is a robust solar module with 72 solar cells. These modules can be used for on-grid solar applications. Our meticulous design and production techniques ensure a high-yield, long-term performance for every module produced. Our rigorous quality control and in-house testing facilities guarantee Canadian Solar's modules meet the highest quality standards possible.

Applications

- Utility
- Commercial/industrial roof-tops
- Rural area applications
- Other on-grid and off-grid applications

Quality Certificates

- IEC 61215 / IEC 61730, UL 1703, CEC Listed, CE, MCS
- ISO9001: 2008: Standards for quality management systems
- ISO/TS16949:2009: The automotive quality management system

Environment Certificates

- ISO14001:2004: Standards for Environmental management systems
- QC080000 HSPM: The Certification for Hazardous Substances Regulations



CS6X-265/270/275/280/285P MaxPower

Electrical Data

	CS6X-265P	CS6X-270P	CS6X-275P	CS6X-280P	CS6X-285P
Nominal Maximum Power at STC (Pmax)	265W	270W	275W	280W	285W
Optimum Operating Voltage (Vmp)	35.1V	35.3V	35.5V	35.6V	35.8V
Optimum Operating Current (Imp)	7.55A	7.65A	7.76A	7.86A	7.96A
Open Circuit Voltage (Voc)	43.9V	44.1V	44.1V	44.2V	44.3V
Short Circuit Current (Isc)	8.10A	8.19A	8.31A	8.42A	8.53A
Operating Temperature	-40°C~+85°C				
Maximum System Voltage	1000V (IEC) /600V (UL)				
Maximum Series Fuse Rating	15A				
Power Tolerance	+5W				
Temperature Coefficient	Pmax	-0.43%/°C			
	Voc	-0.34 %/°C			
	Isc	0.065 %/°C			
	NOCT	45°C			

Under Standard Test Conditions (STC) of irradiance of 1000W/m², spectrum AM 1.5 and cell temperature of 25°C

Mechanical Data

Cell Type	Poly-crystalline
Cell Arrangement	72 (6 x 12)
Dimensions	1954 x 982 x 40mm (76.93 x 38.7 x 1.57in)
Weight	27kg (59.52 lbs)
Front Cover	Tempered glass
Frame Material	Anodized aluminium alloy
Standard Packaging (Modules per Pallet)	20pcs

Engineering Drawings

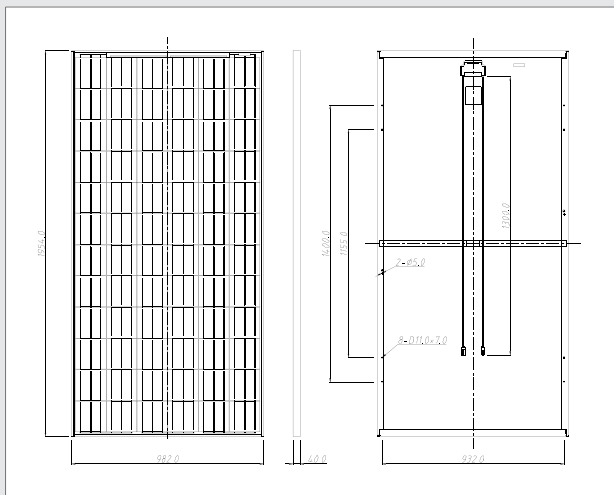

*Specifications included in this datasheet are subject to change without prior notice.

I-V Curves (CS6X-280P)

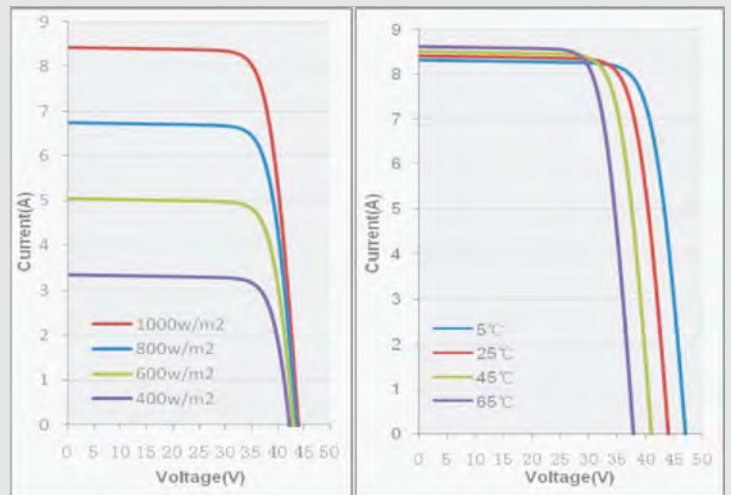

About Canadian Solar

Canadian Solar Inc. is one of the world's largest solar companies. As a leading vertically-integrated manufacturer of ingots, wafers, cells, solar modules and solar systems. Canadian Solar delivers solar power products of uncompromising quality to worldwide customers. Canadian Solar's world class team of professionals works closely with our customers to provide them with solutions for all their solar needs.

Canadian Solar was founded in Canada in 2001 and was successfully listed on NASDAQ Exchange (symbol: CSIQ) in November 2006. Canadian Solar has expanded its cell capacity to 800MW and module capacity to 1.3GW in 2010.

Headquarters | 650 Riverbend Drive, Suite B
Kitchener, Ontario | Canada N2K 3S2
Tel: +1-519-954-2057
Fax: +1-519-578-2097
inquire.ca@canadiansolar.com
www.canadiansolar.com

APPENDIX 'C'

Array Racking



GROUND-MOUNT for FRAMED Solar Panels



Use ordinary mounting hardware, and a single array of solar panels can take almost 45 minutes to assemble and install in the field. Use the Solar FlexRack, and your array can be set up and ready for sliding in of framed panels in under THREE minutes! And the flow of installation continues uninterrupted: as workers are finishing bolting down one Solar FlexRack, the next one is already being positioned in place.

Over \$500,000
in Labor Cost Savings per
10MW Project

Do the math: during a full workday, a crew that installs 10 sets of ordinary mounting hardware should be able to install as many as ONE HUNDRED FIFTY Solar FlexRacks! What will that do for your project's cost per watt?

Key features:

- pre-assembled for easy installation
- lightweight for easy handling
- passes both snow and wind load criteria
- adapts to a variety of ground posts
- multiple configurations available:
2 x 4, 2 x 6, 2 x 10, 2 x 12
- custom configurations upon request
- ships economically on a flatbed truck
- corrosion-resistant

"...the pre-assembly of these units has greatly increased our installation rates. We think the product is great..."

Tom Hughes –
M. Sullivan & Sons Ltd



U.S. and International: 1-888-380-8138 | Canada: 1-613-366-2008
www.SolarFlexRack.com

THE FUTURE IS UNFOLDING... QUICKLY

SOLAR FLEXRACK
THE FUTURE IS UNFOLDING... QUICKLY

GROUND-MOUNT for FRAMED Solar Panels



The Solar FlexRack can accommodate solar modules in both portrait and landscape orientation. Installation is fast and easy, and the Solar Flex Rack's unique power-grab clip facilitates the installation of heavy modules. When you combine this with the installation speed of the Solar FlexRack itself, you can greatly reduce your balance of system cost by using the Solar FlexRack.

Over \$500,000
in Labor Cost Savings per
10MW Project

Solar FlexRack features:

- pre-assembled at the factory
- unfolds at the site for easy installation
- lightweight for easy handling
- PE-certified for wind and snow loads
- adapts to a variety of ground posts
- complete wire management via innovative cable tray design

"...proven to be an exceptional product"

Matthew Leslie – enXco

"...a revolutionary cost saver"

David Weinberg – Apogee Solar

FIT compliant

U.S. and International: 1-888-380-8138 | Canada: 1-613-366-2008
www.SolarFlexRack.com

THE FUTURE IS UNFOLDING...QUICKLY

SOLAR
FLEXRACK
THE FUTURE IS UNFOLDING...QUICKLY

ISYS GROUND MOUNT

Imagine BIG Possibilities

Subassembly

ISYS' unique, smart design allows for pre-fabrication of subassemblies prior to delivery to project sites.

Specifications: 50 ksi A653-G50 Carbon Steel
G90 Hot Dipped Galvanized Coating

Warranty

ISYS is covered by a 20-year limited product warranty. For complete warranties, visit our website at www.unirac.com.

Foundation

Engineered to accommodate every foundation option (driven pile, pre-cast concrete ballast, screw type earth auger, traditional excavation and concrete pier), ISYS adapts to the project site and enables customers to select the most cost-effective foundation system for their project site.

Hardware

Mounting hardware is galvanized, which is also less expensive than stainless steel.

I-beams

The I-beam components are manufactured by cold rolling, one of the most efficient manufacturing processes, which is significantly more affordable than aluminum ground mount systems.

Specifications: 50 ksi A653-G50 Carbon Steel
G90 Hot Dipped Galvanized Coating

KEY BENEFITS

of ISYS Ground Mount

Bigger and Better

- Extreme strength-to-weight ratio provides longer spans with minimized foundation points
- Bigger components means fewer connections and alignment issues

Superior Value

- Lowest total installed cost in solar
- Installs at a rate of 10 modules per man hour
- Designed to work specifically with your module
- Adapts to any site conditions = cost-effective foundation systems
- Economical steel components and galvanized hardware

Assemble, don't Build

- No fabrication required
- Repeatable installations
- No field drilling or welding

Complete technical support

- Array design, engineering and installation support
- All structural materials from one source

And Cost Effective To Boot.



(javascript:void(0))

Key Benefits

Packed with innovative features, the ISYS Ground Mount is fastest, strongest, most revolutionary PV ground mount solution ever! Optimized for commercial and utility projects ranging from 500 kilowatts to gigawatts and custom designed for each customer's module and site conditions.



Pre-Assemble & Save.

The ISYS Ground Mount allows the pre-assembly of your module columns prior or in parallel to the installation of foundations and racking. Additionally, contractors can build the subassembly or grade land while assembling all modules to our rails in a controlled environment. Both options offer a shorter project turn-around time and reduce field-labor, saving you money.

Adapts to Any Site

Engineered to accommodate virtually every foundation option, the ISYS Ground Mount easily adapts to any project site by allowing customers to select the most cost-effective foundation system for their specific project site.



DATE: 10-Nov-10
 SUBJECT: Fdn Reactions
 BY: VAM



5r x 7c array
Vertical Support Located with 24" Cantilever

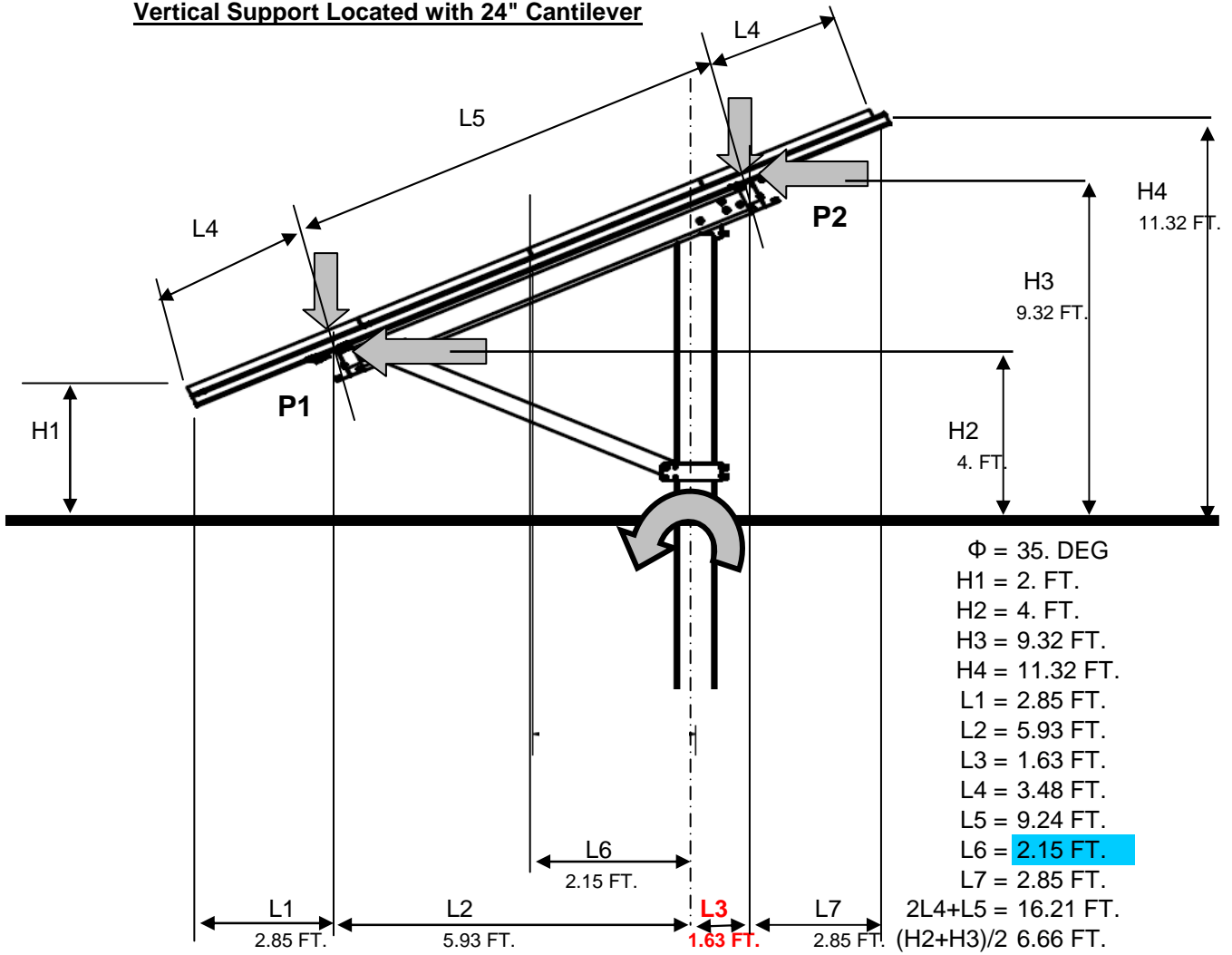

AREA OF ARRAY: 611.86

AREA TO ONE COL: 305.93

	DEAD	SNOW	WIND _{VERT}	WIND _{HORZ}	MAXIMUM REACTIONS		
	kips	kips	kips	kips	MOMENT	AXIAL	SHEAR
	1.25	4.69	2.10	1.47			
1.4 D	1.75				3.77	1.75	
1.25D+1.5S+0.4W	1.57	7.03	0.84	0.59	24.20	9.44	0.59
1.25D+0.5S+1.4W	1.57	2.34	2.94	2.06	28.41	6.85	2.06
0.9D+1.4W*	1.13		-2.94	-2.06	-17.58	-1.81	-2.06

Note: W is for downforce, W* is for uplift



Assemble, Don't Build

With no absolutely fabrication, field drilling or on-site welding required, scalable & repeatable installations are a breeze.



Subassembly Options

A unique, smart design allows for pre-fabrication of subassemblies prior to delivery to project sites with specific challenges, with the ability to



Superior Value

With the lowest total installed cost in solar, the ISYS Ground Mount installs at a rate of 10 modules per hour.



Full Technical Support

Our experienced application engineers will help you optimize your design for maximum power density and return on investment.

Adaptable & Cost Effective Components

Large, galvanized components make for the most versatile, adaptive and cost effective ground mount system available.



(/sites/default/files /igm_s3_lrg_comp4.jpg)

I-beams

The I-beam components are manufactured by cold rolling, one of the most efficient manufacturing processes, which is significantly more affordable than aluminum ground mount systems.



(/sites/default/files /igm_s3_lrg_comp1.jpg)

Slide Clip



(/sites/default/files /igm_s3_lrg_comp2.jpg)

Diagonal Brace

All mounting hardware, such as slide clips, diagonal braces, and U-clamps, is galvanized. This is less expensive than competitive stainless steel products.



(/sites/default/files /igm_s3_lrg_comp3.jpg)

U-Clamp

A Total Commitment To Quality

Single sourced materials, quality craftsmanship and truly innovative design, couple

project, and topped with a limited 20 year warranty. Put any concerns to rest, we have you covered with the best warranty in the industry.



Tested, Then Tested Again

Each and every ISYS Ground Mount system we sell has been through a rigorous quality control process, ensuring your system work from day 1.



A 20 Year Warranty, Though Chances Are You'll Never Need It

It is unlikely you will ever need it, but rest easy knowing we have you covered with an industry best, limited part 20-year warranty.



A Large Team of Multi-Disciplinary Engineers & Dedicated Project Managers At Your Service

Our large team of multi-disciplinary engineers and Project Managers bring both expertise and rigor to each and every project, identifying all the steps necessary to optimize product and project performance, out of the gate and over time.

Functional and Beautiful.



Copyright © 2014 Unirac Incorporated | All rights reserved

[Residential Solutions](#) | [Commercial Solutions](#) | [Utility Solutions](#) | [Environmental Stewardship](#) | [News and Press Releases](#)

[Innovation at Unirac](#) | [Who We Are and What We Do](#) | [Vision and Mission](#) | [Executive Team](#) | [The Hilti Group](#)

ISYS™ GROUND MOUNT

Imagine Big Possibilities



Ground Mount
Solution

Introducing the fastest, strongest, most revolutionary PV ground mount solution ever!

Designed to deliver the most cost effective systems with the most responsive and scalable supply chain, ISYS is optimized for commercial and utility projects ranging from 500 kilowatts to gigawatts and custom designed for each customer's module and site conditions.

The extreme strength to weight ratio of components make ISYS the clear choice for large scale PV projects.

ISYS is assembled in the field, not built. The components require zero fabrication – no field welding, drilling, or cutting. Through smart design and pre-fabricated sub-assemblies, ISYS is one of the fastest systems to install with the least amount of labor.



Visit us online at www.unirac.com

Bright Thinking in Solar



Our experienced application engineers will help you optimize your design for maximum power density and return on investment.

Assisted and supported by a dedicated Project Manager from our Utilities and Commercial Systems Group, a team devoted to supplying a complete suite of services, Unirac provides structural design services, on-site installer training, delivery logistics and field support to ensure accurate installation.

All structural materials for the array come from a single source, specifically packed and designed to work with each customer's module and site conditions.



Visit us online at www.unirac.com

APPENDIX 'D'

Array Foundations



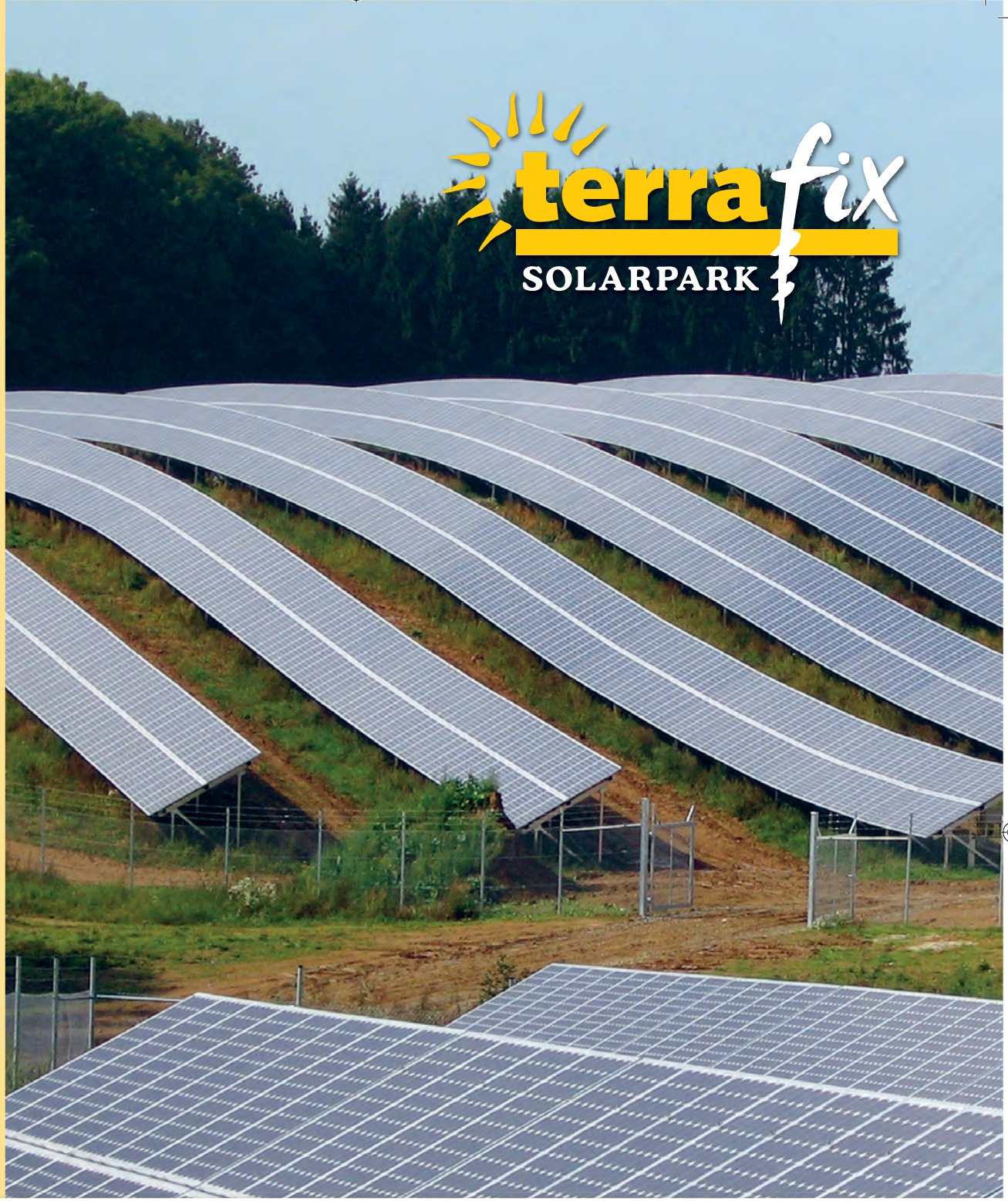

Innovative Solar Foundations and Racking





About us

Terrafix Solarpark provides comprehensive photovoltaic and solar thermal ground mount solutions for commercial and utility-scale projects.

Our expertise is in fixed mounting systems and tracking towers. Our patented concrete-free earth screw foundations uniquely position us to create solutions for the most challenging projects. We are able to install over 40 different earth screw models for use in all geologies, from bedrock to marshy soil. Terrafix Solarpark racking is robust and fully customizable to all topographies.

Our technologies are well tested, as we have successfully deployed over 280 MW of installed capacity throughout Europe and North America.

Our services include:

Engineering • Array Planning & Layout • Designing • Developing • Implementing



Advantages

Earth Screws – Concrete-free Foundations

- No grading required, we avoid the need for concrete foundations and earth moving.
- Minimal Ecological Impact.
- Quick installation up to 100 screws per day – per machine and immediately ready for racking in all weather conditions.
- Easy to remove and reuse.
- Recyclable.
- Foundation solutions for slopes up to 38 degrees.
- Galvanized or stainless steel, composed of single, pressed steel pipe, stronger and more corrosion resistant than welded earth screws.
- Sustains wind loads up to 110 mph and snow loads of 50 psf.
- Earth screws can be loaded immediately (no hardening times, such as for concrete).
- Fast project implementation with any racking system.
- Earth screws do not affect the groundwater.



over
280 MW
installed





Racking Systems

Our racking solutions are robust and can be quickly adapted to suit various wind speeds and terrains.

We provide project specific designs to match string layouts and the local wind and snow conditions. Our racking can be installed rapidly with most panel types. We use height adjustable racks to accommodate varying terrain.

- A typical racking configuration in portrait orientation is 2 panels high and 7 to 8 panels long.
- In landscape orientation, a typical configuration is 4 panels high and 5 long.

The support frames and fasteners are hot dipped galvanized. Base plates of the frames are bolted to earth screw foundations. Support rails are made of aluminum and span up to 24 ft.



Advantages

Racking Systems

- 10 year guarantee: remarkably durable and corrosion resistant with high quality materials. All parts are hot dipped galvanized, stainless steel and aluminum.
- Maximum resistance to high wind speeds (110+ mph) and snow loads (up to 50 psf).
- No grading required: Our racking system is able to follow the contour of any terrain.
- Our continuous racking system uses fewer components, thus maximizing capacity, minimizing cost and lowering maintenance.
- Individual planning, designing and engineering for each project.
- Portrait and Landscape orientation options available.
- We install in the optimal angle for best performance.
- Our system is ideal for thin film, PV and solar thermal.
- Complete systems include earth screws, racking, panel clamps and grounding.

Adjustable racking enables contouring



Earth Screw Types



Compression, Tensile, Lateral Load Testing



Installation Process



- We have over 40 different anchor models for uses across all geologies spanning from hard bedrock to loose marshy soils.



■ Geotechnical capacity table for Terrafix earth screws Type TR1.5-SP3, TR1.5-SP3F

Length: 5', pipe Diameter: 3", Spindle width: 0.6", wing diameter: 5.5"
 Based on on-site tests with maximal deformation in vertical direction of < 1 mm
 Based on on-site tests with maximal deformation in horizontal direction of < 20 mm

Soil Type	Screw Type	Load Type	Geotechnical Capacity Range			
			lower lbs	upper lbs	lower kN	upper kN
Rock	TR1.5-SP3 - Spindle only	Tension Load	6000	8000	26,7	35,6
		Compression load	8000	10000	35,6	44,4
		Lateral load	2000	3000	8,9	13,3
A Clays, Silty clay, Sandy clays, Clay loam	TR1.5-SP3 - Spindle only	Tension Load	3000	6000	13,3	26,7
		Compression load	4000	7000	17,8	31,1
		Lateral load	1000	2000	4,4	8,9
	TR1.5-SP3F - Spindle and Wing	Tension Load	4000	7000	17,8	31,1
		Compression load	5000	8000	22,2	35,6
		Lateral load	1500	2500	6,7	11,1
B Silt, Silt loam, Sandy Loam	TR1.5-SP3F - Spindle and Wing	Tension Load	1500	2000	6,7	8,9
		Compression load	2000	3000	8,9	13,3
		Lateral load	700	1300	3,1	5,8
C Gravel, Sand Loamy Sand	TR1.5-F - Wing only	Tension Load	1000	1500	4,4	6,7
		Compression load	1500	2000	6,7	8,9
		Lateral load	500	1000	2,2	4,4

1. Evaluate terrain, ground type and required loads to determine applicable anchor.
2. Land survey to determine earth screw locations.
3. Drill pilot hole (if required): rock drill, chisel breaker
4. Install earth screw



- For optimized earth screw installation, we modify excavators: Our hydraulic attachments are customized for controlled torque.

Earth Screw Specifications

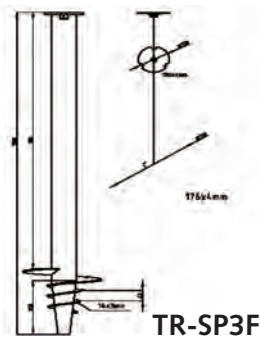
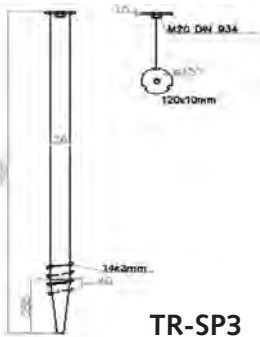

Environmental protection begins with a solid,
environmentally friendly foundation

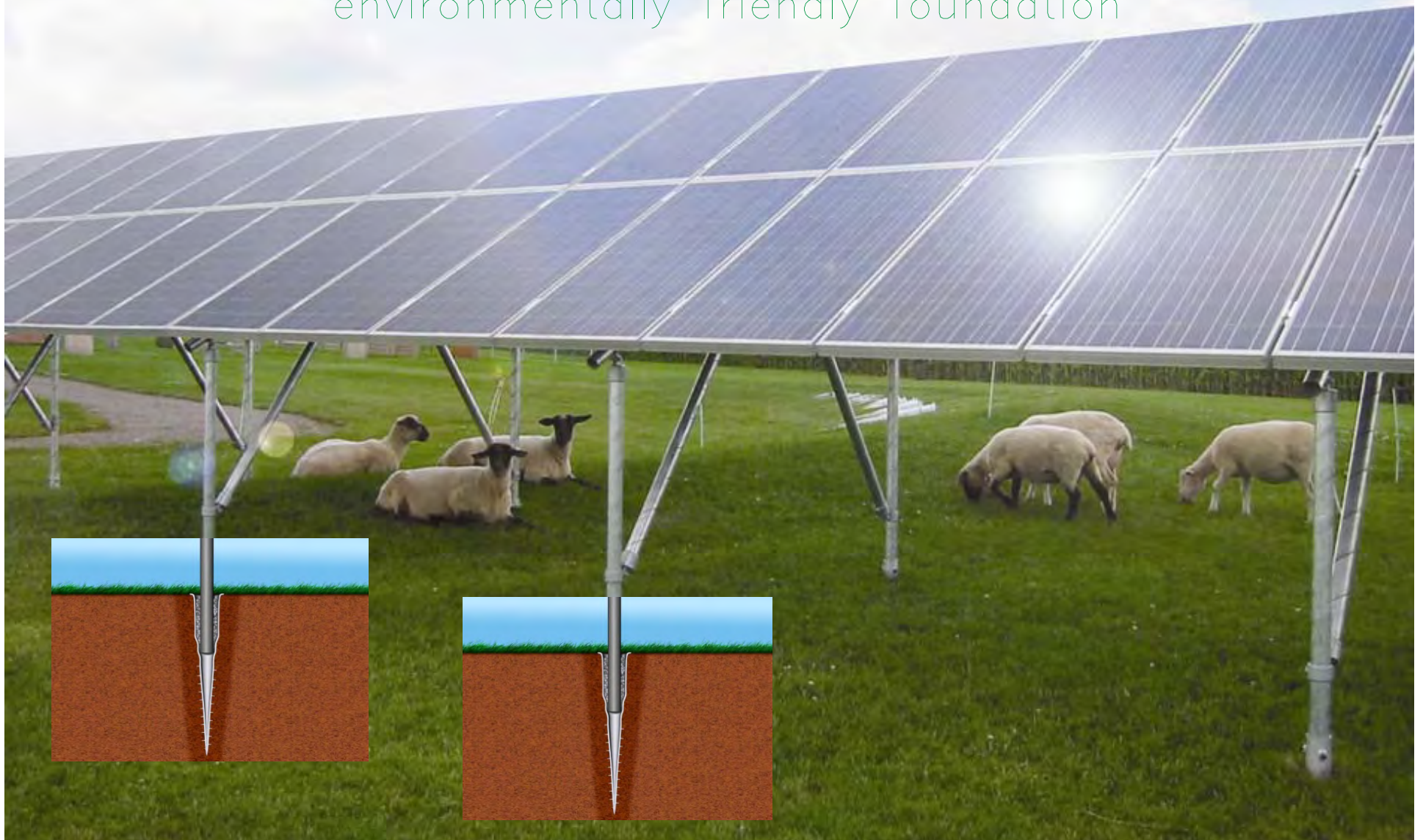

Krinner Ground Screws
provide a solution for
almost every
foundation job

**Moderner
Fundamentbau**

- Kosten- und Zeiterparnis
- statisch geprüft
- eine Graben und Rettenen
- höchste Stabilität
- umweltfreundlich
- hohe Lebensdauer

KRINNER
Schraubfundamente

DER FUNDAMENTPROFI

www.krinner.com





Environment

- *No compression of large areas*
- *Terrain remains undamaged*
- *No interference to spoil surrounding area*
- *Long service life*
- *Cheap and easily removable*
- *Reusable*

Costs And Technology

- *Foundation provided in minutes*
- *No installation waiting time*
- *Can be subjected to loads immediately*
- *Maintenance free*
- *Installation under all weather conditions*
- *Minimum personnel requirements*
- *Cheaper than common foundations*
- *No digging – No concrete*
- *Precise positioning*

The KRINNER installation equipment



Skid Steer mounted
on tracks to protect
the ground surface
on the building site

One man
operation possible
for high cost
efficiency

A man in blue overalls stands next to a red KRINNER Ground Screw machine in a solar field. The machine is a tracked vehicle with a vertical drilling column. In the background, there are rows of solar panels on metal frames in a grassy field under a cloudy sky.

KRINNER is the leading manufacturer of Screw In Foundations for solar fields in Europe. The unique, environmentally friendly, time and cost saving foundation system is used for installations of solar fields and tracker systems in Germany, Spain, France, Italy, Greece and the USA. Where common concrete foundations usually consume a tremendous amount of installation time and money, the KRINNER Ground Screws can be installed in a quarter of the time and are less expensive. The special installation equipment contributes to an almost invisible impact on the building site. And last but not least, the Ground Screws are easy to remove and re-usable.

The KRINNER foundation and
assembly system



KRINNER Ground Screws also provides
a KRINNER created, easy to install
rack system for solar panels

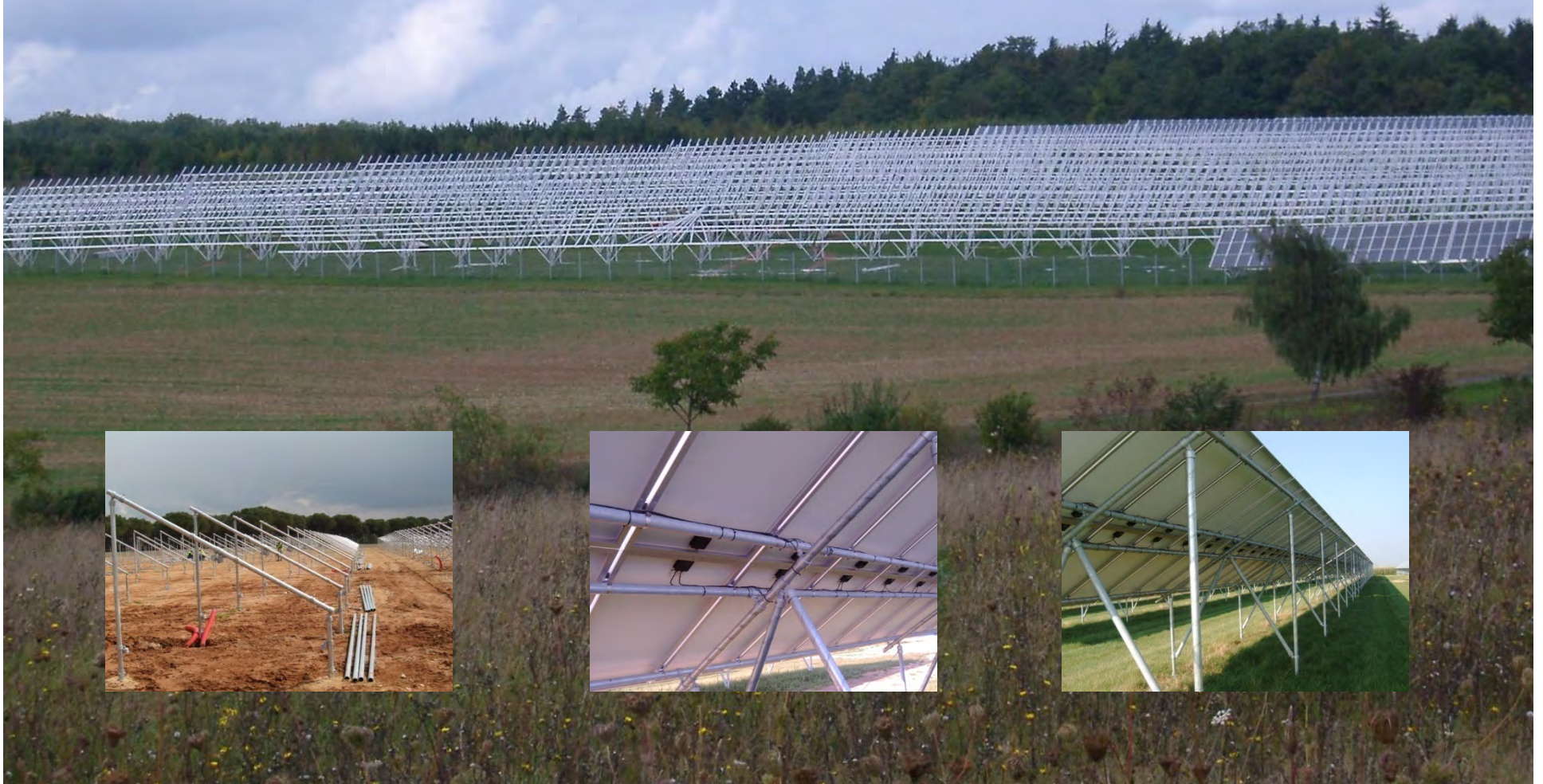

Bobcat mounted installation
mast
movie



KRINNER

Screw-in Support Systems





Represented in
Canada and USA

by
InnoTec Trading Ltd.

Call 1-888-395-7776

Sales Representative

Doug Steven
Phone: 1-250-791-6547
dougsteven@innotectrading.com
www.innotectrading.com

APPENDIX 'E'

Collection Houses and Low-Voltage (DC) Accessories





PV BOX Europe

Additional Features

- Integrated medium voltage switchgear providing grid-connection and transformer feeder with circuit-breaker
- Meets the FNN and BDEW grid-connection requirements of 2010 and 2011
- PV Box available at 500 / 630 / 1000 / 1250 kW power levels

Additional Options

- Monitoring and detection of AC-voltage quality with ION 7650
- Web-based monitoring of the Solar Power Plant with W@de-modules
- Power quality supervision according to EN 50160



PV BOX North America

Additional Features

- Integrated Square D™ Step-up Transformer and Medium Voltage Fused Disconnect

Additional Options

- Web-based SCADA monitoring of the Solar Power Plant

PV BOX

The Schneider Electric PV BOX is a pre-wired equipment package for the European and North American market, specifically designed to meet the growing demand of large scale grid-tied solar farms and large commercial rooftop solar installations. The PV BOX is a complete solution for electrical distribution, automation, security, monitoring and control available from one vendor.

Reduce your costs

Customers can reduce total electrical installation costs and project cycle time with the PV BOX. In addition, by placing the inverters into a structure with a controlled environment, the PV BOX can be installed into a variety of climates, including harsh desert environments where many future large scale solar projects are planned.

What components make up the PV BOX?

The PV BOX typically consists of solar inverters, DC combiner boxes, step-up transformers and a medium voltage switch housed in a prefabricated building to allow quick field wiring from both the solar arrays and the utility grid connection point. Other items can be added to the package including climate controls, security equipment, array string monitoring, SCADA monitoring equipment, and power metering. Custom designs are available using Xantrex™ GT250 E, GT250, GT500 E, GT500 MVX and GT630 E inverters.

Common Features

- Complete solution for electrical distribution, automation, security, monitoring and control
- 250 kW, 500 kW, 1 MW and 2 MW standard and custom configurations available
- Integrated medium voltage transformer with dual secondary windings
- Combiner Box for interconnection with PV-modules
- Minimize field electrical work and minimize installation cost
- Fully pre-wired turn-key solution
- Insulated steel or concrete building
- Combiner Box for PV cables and optimum inverter switching at low level irradiance
- Isolation from grid through AC and DC switching devices under unfavourable generating conditions and at night
- Maximum Power Point Tracking (MPPT) for optimum power extraction from the PV generator
- Single source of procurement
- Global availability and service

Common Options

- Several configurations available upon request
- Climate controls
- Security equipment
- Array string monitoring
- Power metering

PV BOX

Features

- 250 kW, 500 kW, 1 MW and 2 MW standard and custom configurations available
- State-of-the-art inverters and fused combiner boxes
- Insulated steel building
- Square D® Step-up Transformer and Medium Voltage Fused Disconnect
- Optional monitoring and SCADA



PV BOX

(European models available)

The Schneider Electric PV BOX Solar Power Conversion Substation is a pre-wired equipment package for the North American and European market, specifically designed to meet the growing demand of large scale grid-tied solar farms and large commercial rooftop solar installations. The PV BOX is a complete solution for electrical distribution, automation, security, monitoring and control available from one vendor.

Reduce your costs

Customers can reduce total electrical installation costs and project cycle time with the PV BOX. In addition, by placing the inverters into a structure with a controlled environment, the PV BOX can be installed into a variety of climates, including harsh desert environments where many future large scale solar projects are planned.

What components make up the PV BOX?

The PV BOX typically consists of solar inverters, DC combiner boxes, step-up transformers and a medium voltage switch housed in a prefabricated building to allow quick field wiring from both the solar arrays and the utility grid connection point. Other items can be added to the package including climate controls, security equipment, array string monitoring, SCADA monitoring equipment, and power metering. Custom designs are available using Xantrex™ GT500-MV, GT500 E or GT250 inverters.

Several standard configurations available

- 500 kW SPCS for 600 Vdc and 480 V or 600 Vac
- 1 MW SPCS for 600 Vdc and 15 kV to 35 kVac
- 1 MW SPCS for 1000 Vdc and 15 kV to 35 kVac
- 2 MW SPCS for 1000 Vdc and 15 kV to 35 kVac

Other custom sizes and configurations available upon request.



Xantrex™ XW MPPT Solar Charge Controller

Product Features

- Maximum Power Point Tracking (MPPT) delivers maximum available power from PV array to battery bank
- Integrated PV ground-fault protection
- Ultra-reliable, convection-cooled design does not require a cooling fan – large, aluminum, die-cast heat-sink allows full output current up to 45°C without thermal derating
- Selectable two or three stage charging algorithms with manual equalization to maximize system performance and improve battery life
- Configurable auxiliary output
- Two-line, 16-character liquid crystal display (LCD) and four buttons for configuration and system monitoring
- Input over-voltage and under-voltage protection, output over-current protection, and backfeed (reverse current) protection (warning and fault messages appear on LCD when unit shuts down as a protective measure)
- Over-temperature protection and power derating when output power and ambient temperature are high
- Battery Temperature Sensor (BTS) included – automatically provides temperature-compensated battery charging
- Xanbus™-enabled network communications protocol (developed by Xantrex)
- Communicates settings and activity to other Xanbus-enabled devices, such as the XW Hybrid Inverter/Charger, the XW System Control Panel (XW SCP), XW Automatic Generator Start (XW AGS), and other XW Solar Charge Controllers
- Five-year warranty (10 year warranty optional)

> Accessories

Xantrex XW60 MPPT

(European models available)

Electrical specifications

Nominal battery voltage	12, 24, 36, 48, 60 Vdc
Maximum PV array voltage (operating)	140 Vdc
Maximum PV array open circuit voltage	150 Vdc
Array short-circuit current	60 Adc maximum
Maximum and minimum wire size in conduit	#6 AWG to #14 AWG
Total power consumption while operating	2.5 W (tare)
Charger regulation method	Three-stage (bulk, absorption, float) Two-stage (bulk, absorption)

General specifications

Dimensions (H x W x D)	14 ½ x 5 ¾ x 5 ½" (368 x 146 x 138 mm)
Weight (controller only)	10.75 lb (4.8 kg)
Weight (shipping)	17.6 lb (8 kg)
Shipping dimensions (H x W x D)	19 x 9 x 9 ¾" (483 x 229 x 350 mm)
Mounting	Vertical wall mount
Standard warranty	Five years (10 years optional)
Part number	865-1030-1

Environmental specifications

Enclosure type	Indoor, ventilated, sheet metal chassis with 7/8" and 1" (22.22 mm and 27.76 mm) knockouts and aluminum heat-sink
Operating temperature range (full power)	-4 to 113 °F (-20 to +45 °C)
Storage temperature	-40 to 185 °F (-40 to +85 °C)
Altitude limit (operating)	Sea level to 15,000 feet (4572 m) @ 15 °C

Optional accessories

XW System Control Panel	865-1050
XW Automatic Generator Start	865-1060
Network cables:	
3 feet (0.9 m)	809-0935
25 feet (7.6 m)	809-0940
50 feet (15.2 m)	809-0941
75 feet (22.9 m)	809-0942

Regulatory approvals

CSA certified to CSA 107.1, UL 1741 FCC Class B and Industry Canada, CE

Specifications subject to change without notice.



Xantrex™ XW AGS

The XW Automatic Starter is a Xanbus™-enabled device that can automatically activate a generator to provide an XW Series Inverter/ Charger with power to recharge depleted batteries or assist with heavy loads. Compatible with popular generators, this Automatic Starter adds intelligence to power management and eliminates time spent monitoring batteries and inverter loads.



Xantrex™ XW SCP

The XW System Control Panel is a Xanbus™-enabled device featuring a graphical, backlit LCD screen that displays system configuration and diagnostic information. Large keypad buttons, an intuitive onscreen menu system, and plain text status messages make it easy to configure and operate all devices connected to the Xanbus Network.



Xantrex™ Gateway

The Xantrex Communication Gateway bridges the gap between a GT Series or XW System and the system owner's computer, making it the central component for a residential or small commercial remote monitoring system. The Gateway includes both built-in Wi-Fi and Ethernet connectivity allowing for flexible and simple set up for wireless or wired connection to a router or direct to a PC.



Xantrex™ XW CK

The XW Connection Kit is a wiring kit and conduit box used to connect a second inverter to a Xantrex XW Power Distribution Panel. All wires are measured, pre-cut and labeled to facilitate quick and easy installation.



Xantrex™ XW CB

The Conduit Box, is a bare conduit box (no wires) that can be used to create systems larger than two inverters, or to retrofit XW Inverters into existing systems which may already have AC/DC disconnects.



Xantrex™ XW PDP

The Xantrex XW Power Distribution Panel with conduit box is factory-wired and labeled to support a code-compliant single-inverter installation. Internal wiring and breakers can be added to expand the XW System with up to three inverters, four charge controllers, or other equipment to support larger systems.

Xantrex is now Schneider Electric!



Our transformation to Schneider Electric ensures our global leadership position in the renewable energy market. We've been trusted innovation leaders for over 20 years manufacturing residential, small and large commercial inverters.

As part of the Schneider Electric brand of companies, such as Square D, APC and Pelco, we can confidently design and deliver complete renewable energy solutions. As a global leader in energy management, we want to be your partner and help you make the most of your energy.



www.schneider-electric.com

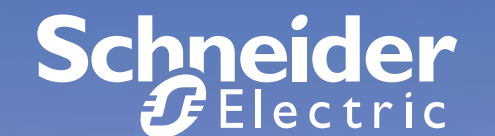

APPENDIX 'F'

Inverters





**ONTARIO FIT
COMPLIANT**



Schneider Electric Xantrex™ GT500 Grid Tie Solar Inverter

Features

- Ultra-efficient design with CEC efficiency of 97% (GT500 MVX version)
- Option to connect directly to medium voltage using a customer supplied transformer or transformer supplied by Schneider Electric
- Integrated design with isolation transformer (480V and 600V only) in one unit
- Includes AC and DC disconnects for both 480 V and MV versions
- Integrated ground-fault detection and interruption
- Soft-start circuit to reduce nuisance trips (480V and 600V only)
- Sealed design does not require filters or external air to cool sensitive components
- Back and sides of unit designed for zero clearance installations to minimize inverter space requirements
- Wiring access points on bottom, sides and back of inverter
- Removable air outlet allows inverter to be mated with venting ductwork
- Designed for fork lift or sling transportation
- Zinc primed and powder coated steel enclosure for maximum corrosion resistance
- Designed to help maximize reliability with film-type capacitors and bus bars in the power path
- Bright fluorescent green Vuum display with UV cover for ease of reading in sunlight
- RS485/Modbus and RS232 communications
- Available with a five-year standard warranty, extendable to ten years
- Ontario FIT Compliant (most models)

Options

- PV Box solution with multiple inverters and medium voltage transformers
- Fused sub-array combiner integrated with the inverter enclosure
- Sub-array string monitoring
- Positive-ground configuration
- Remote monitoring and control options
- Preventative maintenance programs
- Uptime guarantees and service contracts for up to 20 years



Xantrex™ GT500 Inverters

Electrical specifications

Models	GT500 480 (preliminary)	GT500 600 (preliminary)	GT500 MVX
Input (DC)			
MPPT, voltage range	310 to 480 V	310 to 480 V	310 to 480 V
Max. open circuit voltage	600 V	600 V	600 V
Max. DC current	1700 A	1700 A	1700 A
Max. DC short circuit current	2200 A	2200 A	2200 A
Max. utility backfeed current	0 A	0 A	0 A
Night time tare loss	< 100 W	< 100 W	< 100 W
Output (AC)			
Max. continuous output power	500 kW	500 kW	500 kW
Nominal AC voltage	480 V	600 V	208 V (for direct connection to a medium voltage isolation transformer)
Nominal frequency	60 Hz	60 Hz	60 Hz
Nominal AC current	602 A	482 A	1388 A
Max. AC current	TBD	TBD	2550A
Power factor	> 0.99	> 0.99	> 0.99
Total harmonic distortion (THD)	< 3% at rated power	< 3% at rated power	< 3% at rated power

Efficiency

Peak	97.3% (est)	97.3% (est)	98% not including MV transformer
CEC weighted	96.5% (est)	96.5% (est)	97% not including MV transformer

General specifications

Enclosure rating	NEMA 3R	NEMA 3R	NEMA 3R
Enclosure	Steel	Steel	Steel
Weight	2268 kg (5000 lb)	2268 kg (5000 lb)	1587 kg (3499 lb)
Dimensions (H x W x D)	224.6 x 379.8 x 126 cm (88.4 x 149.5 x 49.6 in)	224.6 x 379.8 x 126 cm (88.4 x 149.5 x 49.6 in)	224.6 x 228.6 x 126 cm (88.4 x 90.0 x 49.6 in)
Operating temperature range	-20°C to 45°C (-4°F to 113°F) low temperature option available down to -35°C, power derating above 45°C		
Altitude limit	up to 2012 m (6600 ft) without de-rating		
Relative humidity	0 to 95% non-condensing		
Noise emission	< 75 dBA	< 75 dBA	< 75 dBA
Part number	TBD	TBD	820-0049-01-01*

Features and options

Cooling method	Forced convection cooling/sealed design
Display	Standard bright fluorescent green Vuum display
Communications	Optional RS485/Modbus and RS232 communications interface kit
AC/DC disconnect	Standard and integrated within the inverter enclosure
Isolation transformer	Standard and integrated within the inverter enclosure (480 V and 600 V only)
Ground-fault detection/interruption	Standard and integrated within the inverter enclosure
Sub-array container	Optional beside the inverter, 100 A 150 A or 200 A circuits

Regulatory approvals

Safety	UL1741 rev. 2005, CSA 107.1
Interconnect	IEEE 1547 and CSA 107.1

Specifications are subject to change without notice.
 * Other options available upon request.



Main

Range of product	Xantrex GT
Device short name	GT500-MVX
Product or component type	Grid-tie solar inverter
Network number of phases	Three phase
Nominal output power	500 kW AC

Complementary

Output voltage	208 V +10 % -12 % AC three phase
Output current	1400 A AC
Peak output current	2850 A 29.4 ms
Network frequency	60 Hz +0.5 Hz -0.7 Hz (output)
Cos phi	> 0.99 above 20 % rated power
Harmonic distortion	< 3 % at rated power
Input voltage	<= 600 V DC open circuit 310 - 600 V DC 310 - 480 V DC MPPT
Input current	1700 A DC
Utility backfeed current	0 A
Overcurrent protection	1800 A (output)
Power consumption in W	< 100 W night time
Feature available	Standard integrated AC and DC disconnects Standard ground fault protection Optional RS485/Modbus or Ethernet communications interface kit Optional external medium voltage isolation transformer Optional sub-array combiner with 100A or 200A circuits and string monitoring
Display type	VFD
Messages display capacity	4 lines
Enclosure material	Steel
Surface finish	Powder coated Zinc primed
Type of cooling	Forced convection (depending on temperature)
Device mounting	Floor mounted
Height	2246 mm
Width	2286 mm
Depth	1260 mm
Product weight	1587 kg

Environment

Ambient air temperature for operation	-20...50 °C (full power at 45 °C)
Operating altitude	2000 m without derating
NEMA degree of protection	NEMA 3R
Acoustic level	< 75 dBA
Relative humidity	0...95 % non-condensing
Standards	CSA 107.1 UL 1741 IEEE 1547

Xantrex™ GT500 Grid Tie Solar Inverter



Features

- Ultra-efficient design with CEC efficiency of 97% (GT500-MVX version)
- Option to connect directly to medium voltage using a customer supplied transformer or transformer supplied by Schneider Electric
- Integrated design with isolation transformer (480 V only) in one unit
- Includes AC and DC disconnects for both 480 V and MV versions
- Integrated ground-fault detection and interruption
- Soft-start circuit to reduce nuisance trips (480 V only)
- Sealed design does not require filters or external air to cool sensitive components
- Back and sides of unit designed for zero clearance installations to minimize inverter space requirements
- Wiring access points on bottom, sides and back of inverter
- Removable air outlet allows inverter to be mated with venting ductwork
- Designed for fork lift or sling transportation
- Zinc primed and powder coated steel enclosure for maximum corrosion resistance
- Designed for maximum reliability with film-type capacitors and bus bars in the power path
- Bright fluorescent green vacuum display with UV cover for ease of reading in sunlight
- RS485/Modbus and RS232 communications
- Available with a five-year standard warranty, extendable to ten years

Options

- PV Box solution with multiple inverters and medium voltage transformers
- Fused sub-array combiner integrated with the inverter enclosure
- Sub-array string monitoring
- Positive-ground configuration
- Remote monitoring and control options
- Preventative maintenance programs
- Uptime guarantees and service contracts for up to 20 years

Xantrex GT500 (European models available)

Electrical specifications

	GT500-480 (preliminary)	GT500-MVX
Maximum continuous output power	500 kW	500 kW
Nominal output voltage	480 Vac	208 Vac (for direct connection to a medium voltage isolation transformer)
Nominal output frequency	60 Hz	60 Hz
Maximum output current	614 A rms	1400 A rms
Maximum output fault current	2550 A	2550 A (peak for 29.4 msec)
Power factor	> 0.99	> 0.99
DC input voltage range	310 to 600 Vdc	310 to 600 Vdc
Peak power tracking voltage range	310 to 480 Vdc	310 to 480 Vdc
Maximum input current	1700 Adc	1700 Adc
Maximum input short-circuit current	3200 Adc	3200 Adc
Maximum backfeed current	0 Adc	1400 Adc
Peak inverter efficiency	97.0% (est)	98% not including MV transformer
CEC efficiency	96.0% (est)	97% not including MV transformer
Night-time power consumption	< 100 W	< 100 W
Maximum output over-current protection	800 A	1800 A

General specifications

Operating temperature range	-4°F to 113°F (-20°C to 45°C) low temperature option available down to -35°C, power derating above 45°C	
Enclosure rating	NEMA 3R	NEMA 3R
Unit weight	5000 lbs (est) (2268 kg)	3500 lbs (1587 kg)
Inverter dimensions (H x W x D)	88.4 x 149.5 x 49.6 in 2246 x 3798 x 1260 mm	88.4 x 90.0 x 49.6 in 2246 x 2286 x 1260 mm
Noise	< 70 dBA	< 70 dBA
Altitude	up to 6600' (2012 m) without de-rating	
Relative humidity	0 to 95% non-condensing	

Regulatory approvals

Certified to UL 1741 (2005 Edition) and CSA 107.1-01
Tested to IEEE 1547

Specifications subject to change without notice.

APPENDIX 'G'

Secondary Transformers (at collection houses)



Padmount Liquid Filled Transformers

For use on underground power distribution systems.

[Overview](#) [Documents & Downloads](#)

Square D® three-phase, pad-mounted liquid-filled transformers, for use on underground power distribution systems, meet modern design requirements for flexibility, and provide a low profile, visually pleasing installation. Construction allows installation in locations accessible to the general public without the need for protective fencing or vaults.

These transformers are designed to meet all applicable industry standards of ANSI, NEMA, CSA and IEEE.

Available in primary voltages from 2.4 kV to 46 kV in 45 through 20,000 KVA sizes 600 volt through 25 kV secondary ratings are available.

Features

- UL label option
- Factory Mutual Listing option
- High efficiency TP1 design option
- Compact, low profile design
- Sealed tank construction
- Indoor high fire-point fluids available
- Tamper-resistant design
- Higher standard impulse levels than dry type units
- Self-cooled overload capabilities
- Copper or aluminum windings
- Loop feed option available
- Fusing and switching options
- Available in live or dead front construction
- Surge arrester options
- Secondary busway connection option
- Secondary circuit breaker options
- I-Line® Distribution panel option



Pad-Mounted, Small Power Transformers

75–20,000 kVA, 2.5–46 kV Primary Voltage, 120 V–25 kV Secondary Voltage Class 7230

Retain for future use.

Introduction

Three-phase, pad-mounted transformers, for use on underground power distribution systems, are best suited for commercial applications in public access areas and where underground service is required. These transformers meet modern design requirements for flexibility and provide a visually pleasing installation. Construction allows installation in locations accessible to the general public without the need for protective fencing or vaults. These units are ideally suited for apartment buildings, schools, hospitals, shopping centers, commercial buildings, or industrial sites. Standard, liquid-filled sizes range from 75–20,000 kVA, with primary ratings from 2.5–46 kV.



Environmental Information

- Sealed tank construction
- Special waste disposal considerations

Ratings

- 75–20,000 kVA
- Primary voltage: 2.5–46 kV
- Secondary voltage: 120 V–25 kV
- Insulation temperature limit: 120 °C
- Temperature rise: 65 °C (standard); 55 °C or 55/65 °C (optional)

Certifications

- ISO 9001 registered
- Optional UL and cUL certification
- Optional Factory Mutual listing
- DOE 2010 Energy Efficient (75–2500 kVA)

Special Design Options

- Special sound requirements
- Special altitude requirements
- Retrofit designs
- Higher efficiency requirements
- Special ambient conditions

Applicable Standards

- IEEE C57.12.00—Standard General Requirements for Liquid-Immersed Distribution, Power, and Regulating Transformers
- IEEE C57.12.34—Requirements for Pad-Mounted, Compartmental-Type, Self-Cooled, Three-Phase Distribution Transformers, 2,500 kVA and Smaller: High Voltage, 34,500 GrdY/ 19,920 V and Below; Low Voltage, 480 V and Below
- IEEE C57.12.28—Standard for Pad-Mounted Equipment—Enclosure Integrity
- IEEE C57.12.70—Standard for Terminal Markings and Connections for Distribution and Power Transformers
- IEEE C57.12.80—Standard Terminology for Power and Distribution Transformers
- IEEE C57.12.90—Standard Test Code for Liquid-Immersed Distribution, Short-Circuit Testing of Distribution and Power Transformers
- IEEE C57.13—Requirements for Instrument Transformers
- ANSI/IEEE 386—Separable Insulated Connector Systems for Power Distribution Systems Above 600 V
- ASTM D877—Test Method for Dielectric Breakdown Voltage of Insulating Liquids Using Disk Electrodes
- NEMA AB1—Molded Case Circuit Breakers
- NEMA TR1—Transformers, Regulators, and Reactors

Specifications

- A. The transformer(s) shall be compartment type, self-cooled, for mounting on a pad and shall comply with the latest applicable standards.
- B. The average temperature rise of the windings, measured by the resistance method, shall be [55] [65] [55/65] °C when the transformer is operated at the rated kVA output in a 40 °C ambient. The transformer shall be capable of being operated at the rated load in a 30 °C average, 40 °C maximum ambient, as defined by IEEE C57.12.00, without loss of service life expectancy.
- C. Content and insulating fluid shall be [inhibited mineral oil] [less flammable hydrocarbon fluid] [less flammable seed oil-based fluid].
- D. The high and low voltage compartments shall be located side by side, separated by a steel barrier. When facing the transformer, the low voltage compartments shall be on the right. Terminal compartments shall be full height, air-filled, with individual doors. The high voltage door fastenings shall not be accessible until the low voltage door has been opened.
- E. The following accessories shall be provided as standard on all transformers:
 1. Nameplate in low voltage compartment.
 2. One-inch upper filter press and filling plug [one-inch drain plug] [one-inch drain valve with sampling device].
 3. Drain plug provided on 75–500 kVA. Drain valve provided on units rated above 500 kVA.
 4. [Lightning arrester mounting provisions in live front units only.]
 5. Tap changer, for de-energized operation only, which is externally operable and padlockable.
 6. The front of both compartments shall be removable to allow the transformer to be rolled or skidded into position over conduit stubs.
 7. ANSI tank grounding provisions shall be furnished in both compartments.
- F. The transformer(s) shall be rated [_____] kVA, self-cooled (ONAN). Primary voltage _____ [delta] [wye]. Secondary voltage _____ [delta] [wye], [3-wire] [4-wire], 60 Hz with two 2½% full capacity above normal taps and two 2½% below normal taps. Impedance shall be [_____ %] [manufacturer's standard impedance], ±7½%. Basic impulse level of the primary winding shall be [_____ kV] [as specified in IEEE C57.12.00 for comparable kV class].
- G. The transformer shall be of sealed-tank construction or sufficient strength to withstand a pressure of 7 psi without permanent distortion. The cover shall be welded and the fastenings tamper-resistant. The transformer shall remain effectively sealed for a top oil temperature of -5 °C to 105 °C. When required, cooling panels will be provided on the back and sides of the tank. Lifting eyes and packing pads will be provided.
- H. Coils shall be wound with [copper] [aluminum] conductors.
- I. Core and coil assembly shall be three- or five-legged, using high grade, grain-oriented silicon steel laminations. Magnetic flux is to be kept well below the saturation point.
- J. Transformers connected wye-wye shall be built with four- or five-legged core-type design to avoid the tank heating problems sometimes associated with wye-wye connections.
- K. The high voltage terminations and equipment shall be [live front] [dead front].

- L. Live front bushings shall be porcelain with [clamp-type connector] [blade terminals incorporating a two-hole drilling pattern]. Bushings shall be externally clamped and front removable.
- M. Dead front bushings shall be 200 A, either universal wells or one-piece integrated for use with separable connectors. Bushings shall be externally clamped and front removable.
- N. Dead front bushings shall be 600 A, one-piece integrated, with removable stud, for use with separable connectors. Bushings shall be externally clamped and front removable.
- O. The low voltage bushings shall be molded epoxy, and provided with blade-type spade terminals with NEMA standard hole spacing arranged for vertical take-off. The low voltage neutral shall be an insulated bushing, grounded to the tank by a removable ground strap.
- P. Wye-wye transformers shall have the high and low voltage neutrals internally tied with a removable strap.
- Q. A load break, gang-operated, liquid-immersed switch shall be provided that is externally operable from the high voltage compartment through the use of a distribution hot stick.
- R. Switch to be [two-position "OFF/ON" type for use on a radial feed system] [three-position type for use on an alternate feed system with feed-from-the-left, feed-from-the-right, or OFF] [four-position "sectionalizing" type for use on an extended radial or loop-feed system with feed-from-the-left, feed-from-the-right, isolated-from-either-side, or through-feed-to-both-sides] [two-position switches to be used as "sectionalizing" switches on extended radial or loop-feed systems with feed-from-the-left, feed-from-the-right, isolated-from-either-side, or through-feed-to-both-sides].
- S. Liquid-immersed switch to be rated at [200] [300] [600] A.
- T. Select one of the following options for fusible protection:
 - 1. Internal, liquid-immersed, cartridge fuses sized at _____ A [approximately three times the full-load primary current]
 - 2. Bay-O-Net™ liquid-immersed fuses that are externally replaceable with a hot stick without opening the transformer tank
 - 3. Bay-O-Net liquid-immersed fuses in series with oil-immersed, current-limiting fuses. Bay-O-Net fuses are to be externally replaceable with a hot stick without opening the transformer tank
 - 4. Bay-O-Net liquid-immersed, current-limiting fuses that are externally replaceable with a hot stick without opening the transformer tank.
 - 5. Dry-well, canister-mounted, current-limiting fuses that are externally replaceable with a distribution hot stick without opening the transformer tank
 - 6. McGraw-Edison NX Arc-Strangler® fuses or switchblades in series with NX fuses mounted for cold-sequence connection of incoming radial feed line
- U. Provide three _____ kV distribution class lightning arresters for surge protection. Arresters are to be mounted in the high voltage compartment.

V. Accessories

1. One-inch drain valve with sampling device, 75–500 kVA only; standard on units above 500 kVA
2. Dial-type thermometer
3. Magnetic liquid-level gauge
4. Pressure vacuum gauge
5. Pressure relief valve
6. Automatic pressure relief device (self-resealing with indicator)
7. Mounting provisions for low voltage current transformers and potential transformers
8. Busway opening into the low voltage compartment to accommodate Square D® brand I-Line® busway
9. Molded case circuit breaker in the low voltage compartment rated _____ A, with a 2000 A maximum rating
10. Sudden pressure relay
11. Key interlock to high voltage door
12. kWh meter socket with meter, provided with a hinged, padlockable cover externally mounted on the side of the low voltage compartment

W. Tests shall be conducted in accordance with IEEE C57.12.90, and shall include, as a minimum, the following tests:

1. Ratio
2. Polarity
3. Phase rotation
4. No-load loss
5. Excitation current
6. Impedance voltage
7. Load loss
8. Applied potential
9. Induced potential
10. Quality control impulse

Technical Data

Table 1: Standard Transformer Ratings, Primary Voltage Class 2.5–46 kV, 65 °C Rise, 30 °C Ambient

kVA Self-Cooled	Secondary Voltage			
	208Y/120 V	240 V Delta	480Y/277 V 480 V Delta 600 V Delta	4160Y/2400 V 4160 V Delta 2400 V Delta
75	X	X	X	
112.5	X	X	X	
150	X	X	X	
225	X	X	X	X
300	X	X	X	X
500	X	X	X	X
750	X	X	X	X
1000	X	X	X	X
1500	X	X	X	X
2000		X	X	X
2500		X	X	X
3000			X	X
3750			X	X
5000			X	X

The above combinations are based on standard designs. Voltages above 35 kV and KVA ratings above 5,000, or other than standard designs may place further restrictions on the availability of voltage and kVA combinations. Consult the factory for final determination.

Table 2: Audible Sound Levels

kVA Rating	Decibels (dB)	kVA Rating	Decibels (dB)
75	51	1000	58
112.5	55	1500	60
150	55	2000	61
225	55	2500	62
300	55	3000	63
500	56	3750	64
750	58	5000	66

Table 3: System Voltages and Transformer BIL Ratings

Nominal System Voltage (kV)	Standard and Optional Transformer BIL Ratings									
	30	45	60	75	95	110	125	150	200	250
1.2	S	1								
2.5		S	1							
5.0			S	1						
8.7				S	1					
15.0					S	1				
25.0							S	1		
34.5							2	S	1	
46.0									2	S

S = Standard value.

1 = Optional higher levels where exposure to overvoltage occurs and improved protective margins are required.

2 = Lower levels where protective characteristics of applied surge arresters have been evaluated and found to provide appropriate surge protection.

Table 4: Performance Data

Typical Performance Data					Regulation			
kVA	%IZ	%IR	%IX	X/R	1.0 PF	0.9 PF	0.8 PF	0.7 PF
75	3.50	1.63	3.10	1.91	1.67	2.84	3.17	3.36
112.5	3.50	1.22	3.28	2.69	1.27	2.56	2.96	3.21
150	3.75	1.19	3.56	2.98	1.26	2.66	3.11	3.39
225	4.00	1.13	3.84	3.40	1.20	2.73	3.23	3.55
300	4.00	0.99	3.87	3.90	1.07	2.63	3.15	3.48
500	4.50	1.14	4.35	3.82	1.23	2.98	3.56	3.93
750	5.75	1.00	5.66	5.66	1.16	3.48	4.28	4.80
1000	5.75	0.86	5.68	6.59	1.02	3.37	4.18	4.72
1500	5.75	0.77	5.70	7.38	0.93	3.29	4.12	4.67
2000	5.75	0.84	5.69	6.78	1.00	3.35	4.17	4.71
2500	5.75	0.66	5.71	8.62	0.83	3.20	4.04	4.60
3000	5.75	0.95	5.37	5.98	1.11	3.44	4.24	4.77
3750	5.75	0.93	5.68	6.11	1.09	3.42	4.23	4.76
5000	5.50	0.66	5.71	8.05	0.82	3.20	4.04	4.60

Table 5: Standard % Impedance

kVA	IEEE Standard (Nominal)	Square D (Nominal)	Optional Range
75	1.10–5.75	3.50	2.00–5.00
112.5	1.40–5.75	3.50	2.00–5.00
150	1.40–5.75	3.75	2.00–5.00
225	1.40–5.75	4.00	3.00–5.50
300	1.40–5.75	4.00	3.00–5.50
500	1.70–5.75	4.50	3.50–5.50
750–5000	5.75	5.75	5.00–8.00

Table 6: Typical Performance Data: High Voltage—15 kV Class; Low Voltage—600 V Class

kVA	No Load Losses (Watts)	Full Load Losses ¹ (Watts)	Total Losses (Watts)	Efficiency ¹				
				112%	100%	75%	50% ¹	25%
75	140	1220	1360	98.05	98.22	98.55	98.91	98.86
112.5	250	1370	1620	98.46	98.58	98.80	99.01	98.82
150	290	1790	2080	98.51	98.63	98.86	99.08	98.94
225	370	2540	2910	98.61	98.72	98.95	99.17	99.07
300	490	2980	3470	98.76	98.86	99.05	99.23	99.11
500	610	5700	6310	98.63	98.75	98.99	99.25	99.23
750	880	7530	8510	98.79	98.89	99.10	99.32	99.28
1000	1290	8630	9920	98.93	99.02	99.19	99.36	99.27
1500	1810	11580	13290	99.04	99.12	99.27	99.42	99.33
2000	1670	16790	18460	99.00	99.09	99.23	99.46	99.46
2500	2700	16560	19260	99.17	99.24	99.36	99.49	99.41
3000	5385	28450	33835	98.79	98.88	99.06	99.17	99.05
3750	7700	34850	42550	98.79	98.88	99.04	99.13	98.96
5000	8240	33020	41250	99.12	99.18	99.29	99.34	99.18

¹ Full load losses and efficiencies are at a reference temperature of 85 °C in accordance with IEEE Standard C57.12.91. The efficiencies of transformers with a 75–2,500 kVA rating at 50% load are at a reference temperature of 55 °C in accordance with DOE Test Procedure 10 CFR, Part 431, Subpart K, Appendix A.

Table 7: Primary Phase-to-Phase Voltage—Delta

kVA	2400	4160	4800	7200	8320	12000	12470	13200	13800	14400	20780	22960	24940	26400	34500
75	A,B,C, F,G,I	A,B,C, E,G,I	A,B,C, E,G,I	A,B,C, E,G,I	A,B,C, E,G,I	A,B,C, E,G,I	A,B,C, E,G,I	A,B,C, E,G,I	A,B,C, E,G,I	A,B,C, E,G,I	A,I	A,I	A	A	A
112	A,B,C, G,I,S	A,B,C, E,G,I	A,B,C, E,G,I	A,B,C, E,G,I	A,B,C, E,G,I	A,B,C, E,G,I	A,B,C, E,G,I	A,B,C, E,G,I	A,B,C, E,G,I	A,B,C, E,G,I	A,I	A,I	A	A	A
150	A,B,C,G, I,K,R,S	A,B,C, F,G,I	A,B,C,F, G,I	A,B,C, E,G,I	A,B,C, E,G,I	A,B,C, E,G,I	A,B,C, E,G,I	A,B,C, E,G,I	A,B,C, E,G,I	A,B,C, E,G,I	A,I	A,I	A	A	A
225	A,B,C,H, I,K,R,S	A,B,C, F,G,I,K	A,B,C, F,G,I	A,B,C, E,G,I	A,B,C, E,G,I	A,B,C, E,G,I	A,B,C, E,G,I	A,B,C, E,G,I	A,B,C, E,G,I	A,B,C, E,G,I	A,I	A,I	A	A	A
300	A,B,C,H, I,R,S	A,B,C, F,G,I, K,R,S	A,B,C, F,G,I, K,R,S	A,B,C, E,G,I	A,B,C, E,G,I	A,B,C, E,G,I	A,B,C, E,G,I	A,B,C, E,G,I	A,B,C, E,G,I	A,B,C, E,G,I	A,I	A,I	A	A	A
500	A,K,R,S	A,B,C,H, I,K,R,S	A,B,C,H, K,R,S	A,B,C, F,G,I, K,R,S	A,B,C, F,G,I, K,R,S	A,B,C, F,G,I	A,B,C, F,G,I	A,B,C, F,G,I	A,B,C, F,G,I	A,B,C, F,G,I	A,I	A,I	A	A	A
750	—	A,K,H, R,S	A,C,K, H,R,S	A,B,C, F,G,K, R,S	A,B,C, F,G,K, R,S	A,B,C, F,G,I, K,R,S	A,B,C, F,G,I, K,R,S	A,B,C, F,G,I,K	A,B,C, F,G,I,K	A,B,C, F,G,I,K	A,I	A,I	A	A	A
1000	—	A,K	A,K,R,S	A,B,C,H, R,S	A,B,C,H, K,R,S	A,B,C,H, K,R,S	A,B,C,F, H,K,R,S	A,B,C,F, G,K,R,S	A,B,C,F, G,K,R,S	A,B,C,F, G,K,R,S	A,I,K	A,I,K	A	A	A
1500	—	—	A	A,S	A,R,S	A,C,H, K,R,S	A,C,H, K,R,S	A,C,H, K,R,S	A,C,H, K,R,S	A,C,H, K,R,S	A,K	A,K	A	A	A
2000	—	A	A	A	A	A,R,S	A,R,S	A,C,H, R,S	A,C,H, R,S	A,C,H, R,S	A,K	A,K	A	A	A
2500	—	—	—	A	A	A,R,S	A,R,S	A,R,S	A,R,S	A,R,S	A	A	A	A	A
3000	—	—	—	A	A	A	A	A	A	A	A	A	A	A	A
3750	—	—	—	—	—	—	—	—	—	—	—	—	—	—	—
5000	—	—	—	—	—	—	—	—	—	—	—	—	—	—	—

Legend

A	Weak Link Expulsion Fuse	H	Bay-0-Net Current Sensing Fuse in Series with Parallel Current Limiting Fuse
B	Bay-0-Net Dual Sensing Fuse	I	Drywell Canisters with Current Limiting Fuses
C	Bay-0-Net Current Sensing Fuse	K	Drywell Canisters with Current Limiting Fuses (Parallel)
E	Bay-0-Net Dual Sensing Fuse in Series with Current Limiting Fuse	R	Bay-0-Net High Ampere Overload Sensing Fuse
F	Bay-0-Net Dual Sensing Fuse in Series with Parallel Current Limiting Fuse	S	Bay-0-Net High Ampere Overload with Parallel Current Limiting Fuse
G	Bay-0-Net Current Sensing Fuse in Series with Current Limiting Fuse		

Table 8: Primary Phase-to-Phase Voltage—Wye

kVA	4160Y/ 2400	7200Y/ 4160	8320Y/ 4800	12470Y/ 7200	13200Y/ 7620	13800Y/ 7970	20780Y/ 12000	22960Y/ 13200	24940Y/ 14400	34500Y/ 19920
75	A,B,C,E,G,I	A,B,C,E,G,I	A,B,C,E,G,I	A,B,C,E,G,I	A,B,C,E,G,I	A,B,C,E,G,I	A ¹ ,B ¹ ,C ¹ , E ² ,G ² ,I	A ¹ ,B ¹ ,C ¹ , E ² ,G ² ,I	A ¹ ,B ¹ ,C ¹ , E ² ,G ² ,I ²	A ¹ ,E ² ,G ² ,I ²
112	A,B,C,E,G,I	A,B,C,E,G,I	A,B,C,E,G,I	A,B,C,E,G,I	A,B,C,E,G,I	A,B,C,E,G,I	A ¹ ,B ¹ ,C ¹ , E ² ,G ² ,I	A ¹ ,B ¹ ,C ¹ , E ² ,G ² ,I	A ¹ ,B ¹ ,C ¹ , E ² ,G ² ,I ²	A ¹ ,E ² ,G ² ,I ²
150	A,B,C,F,G,I	A,B,C,E,G,I	A,B,C,E,G,I	A,B,C,E,G,I	A,B,C,E,G,I	A,B,C,E,G,I	A ¹ ,B ¹ ,C ¹ , E ² ,G ² ,I	A ¹ ,B ¹ ,C ¹ , E ² ,G ² ,I	A ¹ ,B ¹ ,C ¹ , E ² ,G ² ,I ²	A ¹ ,E ² ,G ² ,I ²
225	A,B,C,F,G,I,K	A,B,C,E,G,I	A,B,C,E,G,I	A,B,C,E,G,I	A,B,C,E,G,I	A,B,C,E,G,I	A ¹ ,B ¹ ,C ¹ , E ² ,G ² ,I	A ¹ ,B ¹ ,C ¹ , E ² ,G ² ,I	A ¹ ,B ¹ ,C ¹ , E ² ,G ² ,I ²	A ¹ ,E ² ,G ² ,I ²
300	A,B,C,F, G,I,K,R,S	A,B,C,E,G,I	A,B,C,E,G,I	A,B,C,E,G,I	A,B,C,E,G,I	A,B,C,E,G,I	A ¹ ,B ¹ ,C ¹ , E ² ,G ² ,I	A ¹ ,B ¹ ,C ¹ , E ² ,G ² ,I	A ¹ ,B ¹ ,C ¹ , E ² ,G ² ,I ²	A ¹ ,E ² ,G ² ,I ²
500	A,B,C,H, I,K,R,S	A,B,C,F, G,I,K,R,S	A,B,C,F, G,I,K,R,S	A,B,C,F,G,I	A,B,C,F,G,I	A,B,C,F,G,I	A ¹ ,B ¹ ,C ¹ , E ² ,G ² ,I	A ¹ ,B ¹ ,C ¹ , E ² ,G ² ,I	A ¹ ,B ¹ ,C ¹ , E ² ,G ² ,I ²	A ¹ ,E ² ,G ² ,I ²
750	A,K,H,R,S	A,B,C,F,G,K, R,S	A,B,C,F, G,K,R,S	A,B,C,F, G,I,K,R,S	A,B,C,F,G,I,K	A,B,C,F,G,I,K	A ¹ ,B ¹ ,C ¹ , F ² ,G ² ,I	A ¹ ,B ¹ ,C ¹ , F ² ,G ² ,I	A ¹ ,B ¹ ,C ¹ , F ² ,G ² ,I ²	A ¹ ,E ² ,G ² ,I ²
1000	A,K	A,B,C,H,R,S	A,B,C,H, K,R,S	A,B,C,F, H,K,R,S	A,B,C,F, G,K,R,S	A,B,C,F, G,K,R,S	A ¹ ,B ¹ ,C ¹ , F ² ,G ² ,I,K	A ¹ ,B ¹ ,C ¹ , F ² ,G ² ,I,K	A ¹ ,B ¹ ,C ¹ ,F ² , G ² ,I ² ,K ²	A ¹ ,E ² ,G ² ,I ²
1500	A	A,S	A,R,S	A,C,H,K,R,S	A,C,H,K,R,S	A,C,H,K,R,S	A ¹ ,C ¹ ,F ² ,H ² , K,R ² ,S ²	A ¹ ,C ¹ ,F ² ,G ² , K,R ² ,S ²	A ¹ ,C ¹ ,F ² ,G ² , K ² ,R ² ,S ²	A ¹ ,F ² ,G ² , I ² ,K ²
2000	A	A	A	A,R,S	A,C,H,R,S	A,C,H,R,S	A ¹ ,C ¹ ,H ² , K,R ² ,S ²	A ¹ ,C ¹ ,H ² , K,R ² ,S ²	A ¹ ,C ¹ ,F ² ,H ² , K ² ,R ² ,S ²	A ¹ ,F ² ,H ² ,K ²
2500	—	A	A	A,R,S	A,R,S	A,R,S	A ¹ ,R ² ,S ²	A ¹ ,R ² ,S ²	A ¹ ,R ² ,S ²	A ¹ ,K ²
3000	—	A	A	A	A	A	A ¹	A ¹	A ¹	A ¹ ,K ²
3750	—	—	—	—	—	—	—	—	—	—
5000	—	—	—	—	—	—	—	—	—	—

¹ Recommended fuse is limited to GNDY/GNDY transformers with no more than 25% Delta connected secondary load and with neutral internally grounded.

² Recommended fuse is limited to GNDY/GNDY transformers with no more than 50% Delta connected secondary load and with neutral internally grounded.

Legend

A	Weak Link Expulsion Fuse	H	Bay-0-Net Current Sensing Fuse in Series with Parallel Current Limiting Fuse
B	Bay-0-Net Dual Sensing Fuse	I	Drywell Canisters with Current Limiting Fuses
C	Bay-0-Net Current Sensing Fuse	K	Drywell Canisters with Current Limiting Fuses (Parallel)
E	Bay-0-Net Dual Sensing Fuse in Series with Current Limiting Fuse	R	Bay-0-Net High Ampere Overload Sensing Fuse
F	Bay-0-Net Dual Sensing Fuse in Series with Parallel Current Limiting Fuse	S	Bay-0-Net High Ampere Overload with Parallel Current Limiting Fuse
G	Bay-0-Net Current Sensing Fuse in Series with Current Limiting Fuse		

Schneider Electric USA, Inc.
1010 Airpark Center Drive
Nashville, TN 37217 USA
1-888-SquareD (1-888-778-2733)
www.schneider-electric.us

Square D® and I-Line® are registered trademarks of Schneider Electric. Other trademarks used herein are the property of their respective owners.

Electrical equipment should be installed, operated, serviced, and maintained only by qualified personnel. No responsibility is assumed by Schneider Electric for any consequences arising out of the use of this material.

APPENDIX 'H'

Primary Transformer (at project substation)



Substation Liquid Filled Transformers

Used in a wide variety of commercial and industrial applications.

[Overview](#) [Documents & Downloads](#)

Square D® three-phase, substation liquid-filled transformers are used in a wide variety of commercial and industrial applications. These units are designed to meet all applicable industry standards of ANSI, NEMA, CSA and IEEE and are available with mineral oil for outdoor use or high-fire point fluids for indoor use.

Construction allows for stand-alone installation using terminal compartments or close-coupled to primary and secondary switchgear providing a complete substation line-up.

Available in primary voltages from 2.4 kV to 69 kV in 225 through 20,000 kVA sizes, 600 volt through 35 kV secondary voltage ratings are available.

Features

- UL label option
- Factory Mutual Listing option
- High efficiency TP1 design option
- Sealed tank construction
- Indoor high fire-point fluids available
- Higher standard impulse levels than dry type units
- Self-cooled overload capabilities
- Fan-cooled overload capabilities
- Copper or aluminum windings
- Surge arrester options
- Secondary busway connection option
- Rotated design option
- Retro-fit application capabilities



Substation, Small Power Transformers

225–20,000 kVA, 2.5–69 kV Primary Voltage, 120 V–34.5 kV Secondary Voltage
Class 7240

Retain for future use.

Introduction

Liquid-filled, substation transformers are used in a wide variety of commercial and industrial applications. All units are manufactured in accordance with applicable IEEE C57.12.00™ and ANSI C57.12.10 or IEEE C57.36™ standards. The transformers are offered with one of three different fluids:

- Mineral oil
- Dow Corning® 561 silicone transformer liquid (polydimethylsiloxane)
- Fully biodegradable, less flammable, seed-oil-based fluid



Environmental Information

- Sealed tank construction
- Suitable for some poor environments
- Special waste disposal considerations for liquid-filled units

Ratings

- 225–20,000 kVA (fan cooling allows higher kVA ratings)
- Primary voltage: 2.5–69 kV
- Secondary voltage: 120 V–34.5 kV
- Insulation temperature limit: 120 °C
- Temperature rise: 65 °C (standard); 55 °C or 55/65 °C (optional)

Certifications

- ISO 9001 registered
- Optional UL and cUL certification
- Optional Factory Mutual listing
- DOE 2010 Energy Efficient (225–2500 kVA)

Special Design Options

- Special sound requirements
- Special altitude requirements
- Retrofit designs
- Higher efficiency requirements
- Special ambient conditions
- Intertaire, positive pressure, nitrogen gas system
- Conservator (expansion tank) liquid preservation system
- Load tap changers
- Front-of-wave impulse test

Applicable Standards

- IEEE C57.12.00™—Standard General Requirements for Liquid-Immersed Distribution, Power, and Regulating Transformers
- ANSI C57.12.10—Standard for Transformers 230 kV and Below 833/958 Through 8333/10 417 kVA, Single-Phase, and 750/862 Through 60,000/80,000/100,000 kVA, Three-Phase Without Load Tap Changing; and 3750/4687 Through 60,000/80,000/100,000 kVA with Load Tap Changing
- IEEE C57.12.36™—IEEE Standard Requirements for Liquid-Immersed Distribution Substation Transformers
- IEEE C57.12.70™—Terminal Markings and Connections for Distribution and Power Transformers
- ANSI C57.12.28—Switchgear and Transformers, Pad-Mounted Equipment—Enclosure Integrity
- IEEE C57.12.80™—Standard Terminology for Power and Distribution Transformers
- IEEE C57.12.90™—Test Code for Liquid-Immersed Distribution, Power, and Regulating Transformers and Guide for Short-Circuit Testing of Distribution and Power Transformers
- IEEE C57.105™—Guide for Application of Transformer Connections in Three-Phase Distribution Systems
- IEEE C57.109™—Guide for Liquid-Immersed Transformer Through-Fault-Current Duration
- IEEE C57.111™—Guide for Acceptance of Silicone Insulating Fluid and Its Maintenance in Transformers
- IEEE C57.121™—Guide for Acceptance and Maintenance of Less Flammable Hydrocarbon Fluid in Transformers
- CSA-C88—Power Transformers and Reactors

Specifications

- A. The transformer(s) shall be the substation type with [side-wall] [cover] mounted primary and [side-wall] [cover] secondary terminations.
- B. The average temperature rise of the windings, measured by the resistance method, shall be [55] [65] [55/65] °C when the transformer is operated at rated kVA output in a 40 °C ambient. The transformer(s) shall be capable of being operated at rated load in a 30 °C average, 40 °C maximum ambient, as defined by IEEE C57.12.00, without loss of service life expectancy.
- C. Coolant and insulating liquid shall be [inhibited mineral oil] [Dow Corning 561 polydimethylsiloxane silicone transformer fluid] [fully biodegradable, less flammable, seed-oil-based fluid].
- D. Terminations shall be side-wall mounted for: [close-coupling to high and low voltage switchgear sections] [close-coupling to high voltage switchgear on the primary side and terminating in an air-filled terminal chamber for cable connections to the low voltage side] [close-coupling to low voltage switchgear on the secondary side and termination in an air-filled terminal compartment on the primary side for cable entrance] [terminations within air-filled terminal chambers on both high voltage and low voltage side for cable entrance and exit].
- E. Primary and secondary locations shall be as follows: [primary: ANSI Segment 2, *i.e.*, to observer's left when facing the transformer front; secondary: ANSI Segment 4, *i.e.*, to observer's right when facing the transformer front] [primary: ANSI Segment 4, *i.e.*, to observer's right when facing the transformer front; secondary: ANSI Segment 2, *i.e.*, to observer's left when facing the transformer front].
- F. Bushing location and phase rotation shall be coordinated with primary and secondary switchgear to provide correct alignment when switchgear and transformer are connected in the field.
- G. The transformer(s) shall be rated:
[_____kVA ONAN]
[_____/_____kVA ONAN/FONAF]
[_____/_____kVA ONAN/ONAF].
Transformer identification number(s)_____.
Primary voltage_____ [delta] [wye],
secondary voltage_____ [delta] [wye], [3- wire] [4-wire], 60 Hz with two 2½% full capacity above normal and two 2½% full capacity below normal taps. Impedance shall be [_____%] [Manufacturer's standard impedance], ±7½%. Basic impulse level of the primary winding shall be [_____] kV. As specified in IEEE C57.12.00™ for comparable kV class. Sound level, as measured by the NEMA audible sound-level test procedure, shall be less than the values specified in NEMA TR-1 for liquid-filled transformers.
- H. The transformers shall be of sealed-tank construction of sufficient strength to withstand a pressure of 7 psi without permanent distortion. The cover shall be welded. The transformer shall remain effectively sealed for a top oil temperature range of -5 °C to 105 °C. When required, cooling radiators will be provided on the back and front of the tank. Lifting eyes and jacking pads will be provided.
- I. Coils shall be wound with [copper] [aluminum] conductors.
- J. Cores shall be fabricated of high grade, grain-oriented, silicon steel laminations, carefully annealed after fabrication to restore high magnetic permeability. Magnetic flux is to be kept well below the saturation point.

- K. Tank, radiators, and terminal chambers, if provided, shall be treated to remove oil and scale by either shotblast or phosphatizing treatment to provide proper paint adhesion. All exterior surfaces shall be primed, using a high quality, solid, two-part, catalyzed epoxy. Minimum dry film thickness shall be 2 mils. A durably hard polyurethane top coat with a minimum dry film thickness of 1 mil shall be applied to all primed surfaces. The color of the finish coat shall be [ANSI 49] [ANSI 61] [ANSI 70] [ANSI 24] and shall be coordinated with the switchgear manufacturer in order to match the color of the switchgear.
- L. Accessories—The following accessories shall be included on all substation transformers:
1. Pad lockable tap changer for de-energized operation
 2. One-inch upper filling plug and filter press connection
 3. One-inch drain valve with a $\frac{3}{8}$ in. sampler (two-inch drain valve for transformers above 2500 kVA)
 4. Dial type thermometer
 5. Pressure/vacuum gauge [with] [without] bleeder connection
 6. Magnetic liquid level gauge
 7. Pressure relief valve, with manual bleeder and automatic resealing, set to operate at 10 psi with a flow rate of [35 scfm] [50 scfm]
 8. Alarm contacts on [all gauges] [dial thermometer] [liquid level gauge] [pressure vacuum gauge]
 9. Pressure relief diaphragm to operate at 10 psi and relieve 10,000 scfm at 15 psi
 10. Sudden pressure relay permitting remote alarm or trip due to a predetermined rate of pressure rise [with] [without] seal-in delay
- M. The transformer(s) shall be designed for use with fans to increase the kVA capacity in accordance with the listing following Table 1 on page 5. The transformer shall be equipped with forced air-cooling or be designed for the future addition of forced air-cooling. The fan control equipment will be actuated by contacts that sense [the temperature of the top oil] [the average winding temperature] of the transformer. Temperature sensors, motor starter for fan motors, test modes of operation, as well as fans and fan motors, will be provided on units designated ONAN/ONAF. Temperature sensors and details for future mounting of fans and controls will be provided on units designated ONAN/FONAN. Fan motors will operate from a 240 V, single-phase, 60 Hz source of power provided by the user.
- N. Testing shall be conducted in accordance with IEEE C57.12.91™ and shall include, at a minimum, the following tests:
1. Ratio
 2. Polarity
 3. Phase rotation
 4. No-load loss
 5. Excitation current
 6. Impedance voltage
 7. Load loss
 8. Applied potential
 9. Induced potential
 10. Quality control impulse
 11. Temperature (typical data from previous unit is acceptable)
 12. Sound (typical data from previous unit is acceptable)

Technical Data

Table 1: Standard Transformer Ratings, Primary Voltage Class 2.3–46 kV, 65 °C Rise, 30 °C Ambient

kVA Self-Cooled	Secondary Voltage			
	208Y/120 V	240 V Delta	480Y/277 V 480 V Delta 600 V Delta	4160Y/2400 V 4160 V Delta 2400 V Delta
225	X	X	X	X
300	X	X	X	X
500	X	X	X	X
750	X	X	X	X
1000	X	X	X	X
1500	X	X	X	X
2000		X	X	X
2500		X	X	X
3000			X	X
3750			X	X
5000			X	X
7500				X
10,000				X
12,000				X
15,000				X
20,000				X

The above combinations are based on standard designs. Voltages above 35 kV and KVA ratings above 10,000, or other than standard designs may place further restrictions on the availability of voltage and kVA combinations. Consult the factory for final determination.

Forced Air Cooling kVA Capacity

- 15% added kVA capacity for units with an ONAN rating of 225–2000 kVA
- 25% added kVA capacity for units with an ONAN rating of 2500–10,000 kVA
- 33% added kVA capacity for units with an ONAN greater than 10,000 kVA

Table 2: Audible Sound Levels

kVA Rating	Decibels (dB)	kVA Rating	Decibels (dB)
225	55	3000	63
300	55	3750	64
500	56	5000	66
750	58	7500	67
1000	58	10,000	68
1500	60	12,000	69
2000	61	15,000	70
2500	62	20,000	71

Table 3: System Voltages and Transformer BIL Ratings

Nominal System Voltage (kV)	Standard and Optional Transformer BIL Ratings										
	30	45	60	75	95	110	125	150	200	250	350
1.2	S	1									
2.5		S	1								
5.0			S	1							
8.7				S	1						
15.0					S	1					
25.0							S	1			
34.5							2	S	1		
46.0									2	S	
69.0										2	S

S = Standard value.

1 = Optional higher levels where exposure to overvoltage occurs and improved protective margins are required.

2 = Lower levels where protective characteristics of applied surge arresters have been evaluated and found to provide appropriate surge protection.

Table 4: Performance Data

Typical Performance Data					Regulation			
kVA	%IZ	%IR	%IX	X/R	1.0 PF	0.9 PF	0.8 PF	0.7 PF
225	4.00	1.13	3.84	3.40	1.20	2.73	3.23	3.55
300	4.00	0.99	3.87	3.90	1.07	2.63	3.15	3.48
500	4.50	1.14	4.35	3.82	1.23	2.98	3.56	3.93
750	5.75	1.00	5.66	5.66	1.16	3.48	4.28	4.80
1000	5.75	0.86	5.68	6.59	1.02	3.37	4.18	4.72
1500	5.75	0.77	5.70	7.38	0.93	3.29	4.12	4.67
2000	5.75	0.84	5.69	6.78	1.00	3.35	4.17	4.71
2500	5.75	0.66	5.71	8.62	0.83	3.20	4.04	4.60
3000	5.75	1.13	5.64	4.99	1.29	3.58	4.36	4.87
3750	5.75	1.09	5.65	5.18	1.20	3.51	4.30	4.82
5000	5.50	0.78	5.44	6.98	0.99	3.66	4.61	5.23
7500	6.50	0.73	6.46	8.85	0.98	3.87	4.90	5.58
10000	6.50	0.72	6.46	8.97	0.96	3.86	4.89	5.57

Table 5: Standard % Impedance (500 kVA and below)

kVA	Typical	Optional Range
225	4.00	3.00–5.50
300	4.00	3.00–5.50
500	4.50	3.50–5.50
750–5000	5.75	5.00–8.00

Table 6: Standard % Impedance (750 kVA and above)

High Voltage BIL (kV)	Low Voltage Below 2400 V	Low Voltage 2400 V and Above	Optional Range
45–110	5.75 ¹	5.5 ²	5.00–8.00
125–150	6.75	6.5	5.00–8.00
200	7.25	7.0	6.50–8.00
250	7.75	7.5	6.50–8.00
350	—	8.0	—

¹ For transformers greater than 5000 kVA, this impedance is 6.75%.

² For transformers greater than 5000 kVA, this impedance is 6.50%.

Loading

Liquid-filled substation transformers are designed to operate at rated load with rated voltage and frequency applied in “usual service” conditions. It is possible to carry overloads without loss of life expectancy. The following table shows the permissible overloads that may be carried without loss of transformer life expectancy only if occurring once in any 24-hour period given a 65 °C rise transformer in a 30 °C ambient.

ANSI/IEEE Loading Guide

Daily loads above rating to give normal life expectancy. Following and followed by a constant load of:

Peak Load Time (hours)	Times Rated kVA		
	90%	70%	50%
0.5	1.80	2.00	2.00
1	1.56	1.78	1.88
2	1.38	1.54	1.62
4	1.22	1.33	1.38
8	1.11	1.17	1.20

Table 7: Typical Performance Data: High Voltage—15 kV Class; Low Voltage—600 V Class

kVA	No Load Losses (Watts)	Full Load Losses ¹ (Watts)	Total Losses (Watts)	Efficiency ¹					
				133%	125%	100%	75%	50% ¹	25%
225	370	2540	2910	98.40	98.48	98.72	98.95	99.17	99.07
300	490	2980	3470	98.58	98.65	98.86	99.05	99.23	99.11
500	610	5700	6310	98.42	98.50	98.75	98.99	99.25	99.23
750	880	7530	8510	98.60	98.67	98.89	99.10	99.32	99.28
1000	1290	8630	9920	98.77	98.83	99.02	99.19	99.36	99.27
1500	1810	11580	13290	98.89	98.95	99.12	99.27	99.42	99.33
2000	1670	16790	18460	98.83	98.90	99.09	99.23	99.46	99.46
2500	2700	16560	19260	99.05	99.09	99.24	99.36	99.49	99.41
3000	4000	34000	38000	98.42	98.50	98.75	98.98	99.17	99.19
3750	5000	39000	44000	98.54	98.61	98.84	99.05	99.22	99.21
5000	8000	39000	47000	98.86	98.91	99.07	99.21	99.30	99.17
7500	10000	55000	65000	98.94	98.99	99.14	99.28	99.37	99.29
10000	13000	72000	85000	98.96	99.01	99.16	99.29	99.38	99.30

¹ Full load losses and efficiencies are at a reference temperature of 85 °C in accordance with IEEE Standard C57.12.91. The efficiencies of transformers with a 225–2,500 kVA rating at 50% load are at a reference temperature of 55 °C in accordance with DOE Test Procedure 10 CFR, Part 431, Subpart K, Appendix A.

Heat Contribution

Heat contribution is the heat a transformer may contribute to its environment. This may represent additional air conditioning burden in summer months, or may be used in calculating heating requirements during winter months. This heat is the result of transformer losses and is a function, in part, of loading. The following table demonstrates the effect of loading on heat contribution.

**Table 8: Typical Heat Contribution: High Voltage—15 kV Class;
Low Voltage—600 V Class**

kVA	% Load	BTU/Hour	kVA	% Load	BTU/Hour
225	25	1810	2500	25	12755
	50	3435		50	23360
	75	6145		75	41030
	100	9940		100	65775
	125	14820		125	97585
	133	16610		133	109260
300	25	2310	3000	25	20920
	50	4220		50	42690
	75	7400		75	78970
	100	11850		100	129770
	125	17575		125	195080
	133	19675		133	219050
500	25	3300	3750	25	25400
	50	6950		50	50370
	75	13035		75	91990
	100	21550		100	150260
	125	32500		125	225180
	133	36515		133	252665
750	25	4615	5000	25	35645
	50	9435		50	60620
	75	17470		75	102240
	100	28720		100	160505
	125	43185		125	235420
	133	48495		133	262910
1000	25	6250	7500	25	45890
	50	11775		50	81110
	75	20985		75	139800
	100	33880		100	221975
	125	50455		125	327630
	133	56540		133	366390
1500	25	8655	10000	25	59765
	50	16070		50	105865
	75	28425		75	182705
	100	45730		100	290275
	125	67970		125	428580
	133	76135		133	479330
2000	25	9290			
	50	20040			
	75	37955			
	100	63040			
	125	95295			
	133	107130			

Schneider Electric USA, Inc.
1010 Airpark Center Drive
Nashville, TN 37217 USA
1-888-SquareD (1-888-778-2733)
www.schneider-electric.us

Electrical equipment should be installed, operated, serviced, and maintained only by qualified personnel. No responsibility is assumed by Schneider Electric for any consequences arising out of the use of this material.